

High Energy Astrophysics

Dr. Adam Ingram

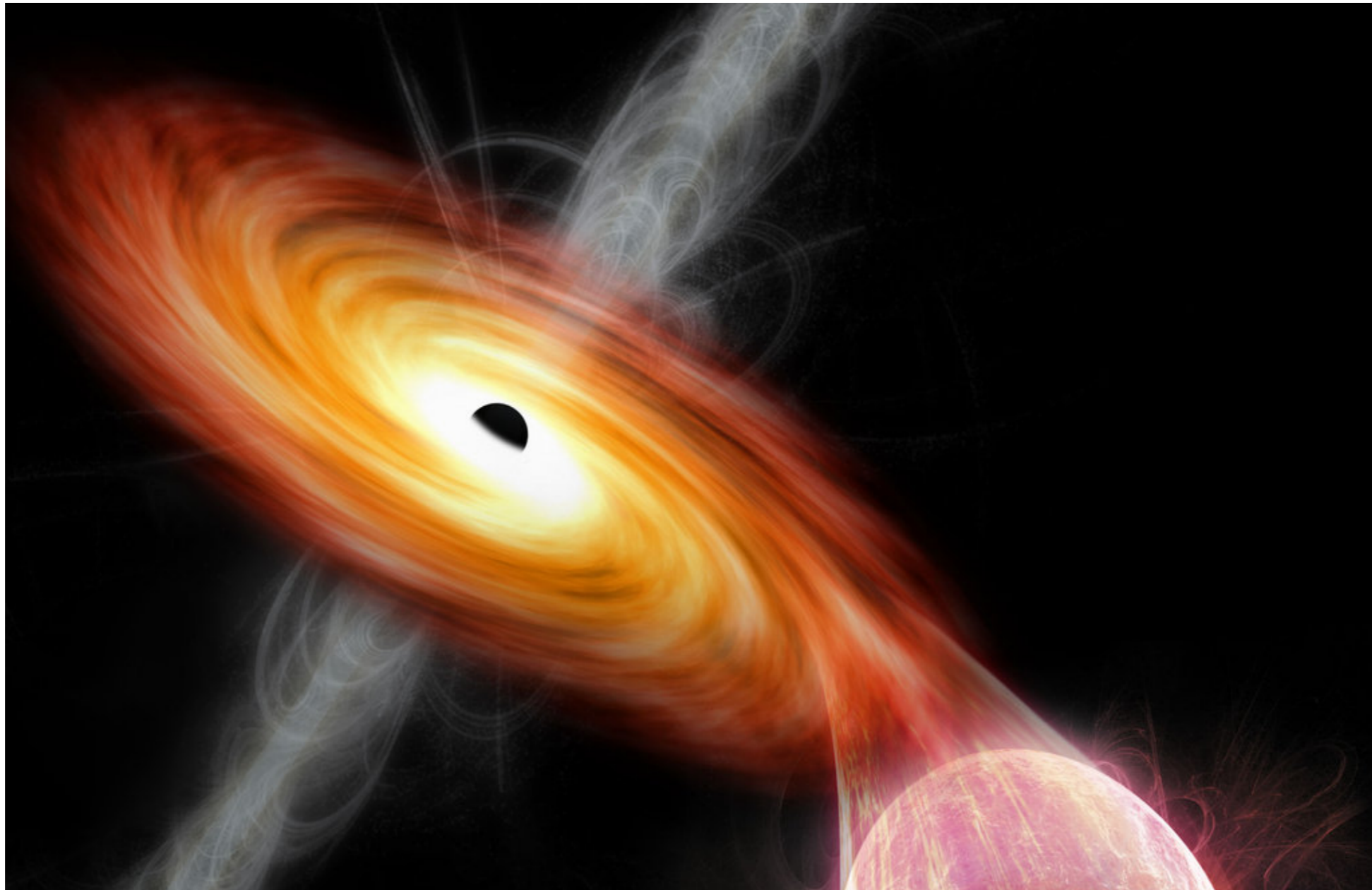

Lecture 10

Galaxy Clusters

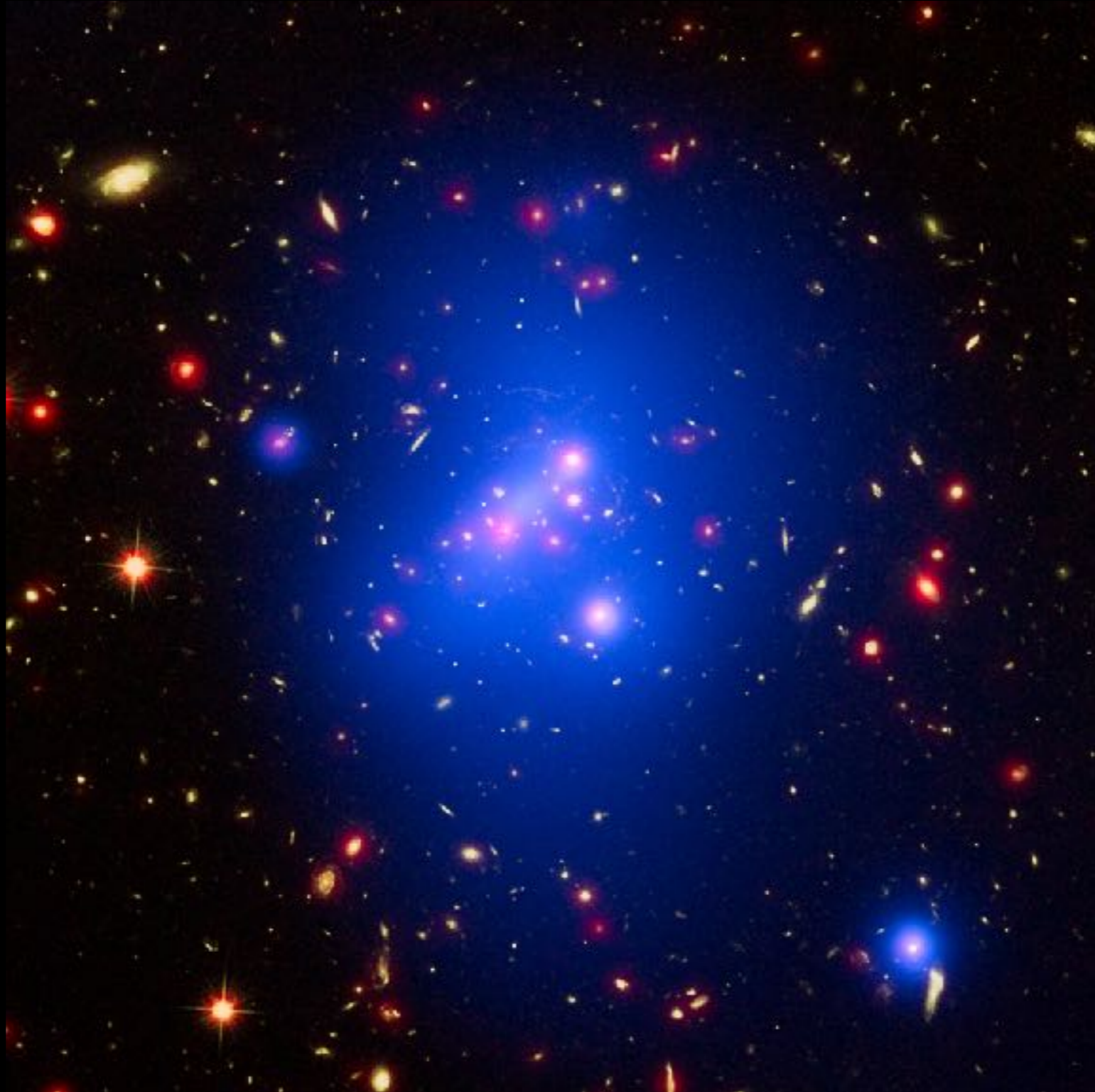

Galaxy Clusters

- Largest gravitationally bound structures in the Universe.
- Intra Cluster Medium (ICM): hot gas in between the galaxies with characteristic temperature $kT \sim 1-15$ keV [$kT=1$ keV $\Rightarrow T=1.16 \times 10^7$ K] — glows in X-rays (blue in picture).
- Dark matter mass $\sim 10 \times$ ICM mass $\sim 10 \times$ mass in stars.
- Typical total mass $\sim 10^{14-15} M_{\odot}$.
- Typically $\sim 100-1000$ galaxies.
- Typical size $\sim 2-10$ Mpc across.

Pictured: Cluster IDCS J1426.5+3508
in X-rays (Chandra, blue), optical (HST,
green) and IR (Spitzer, red). Mass
 $\sim 5 \times 10^{14} M_{\odot}$

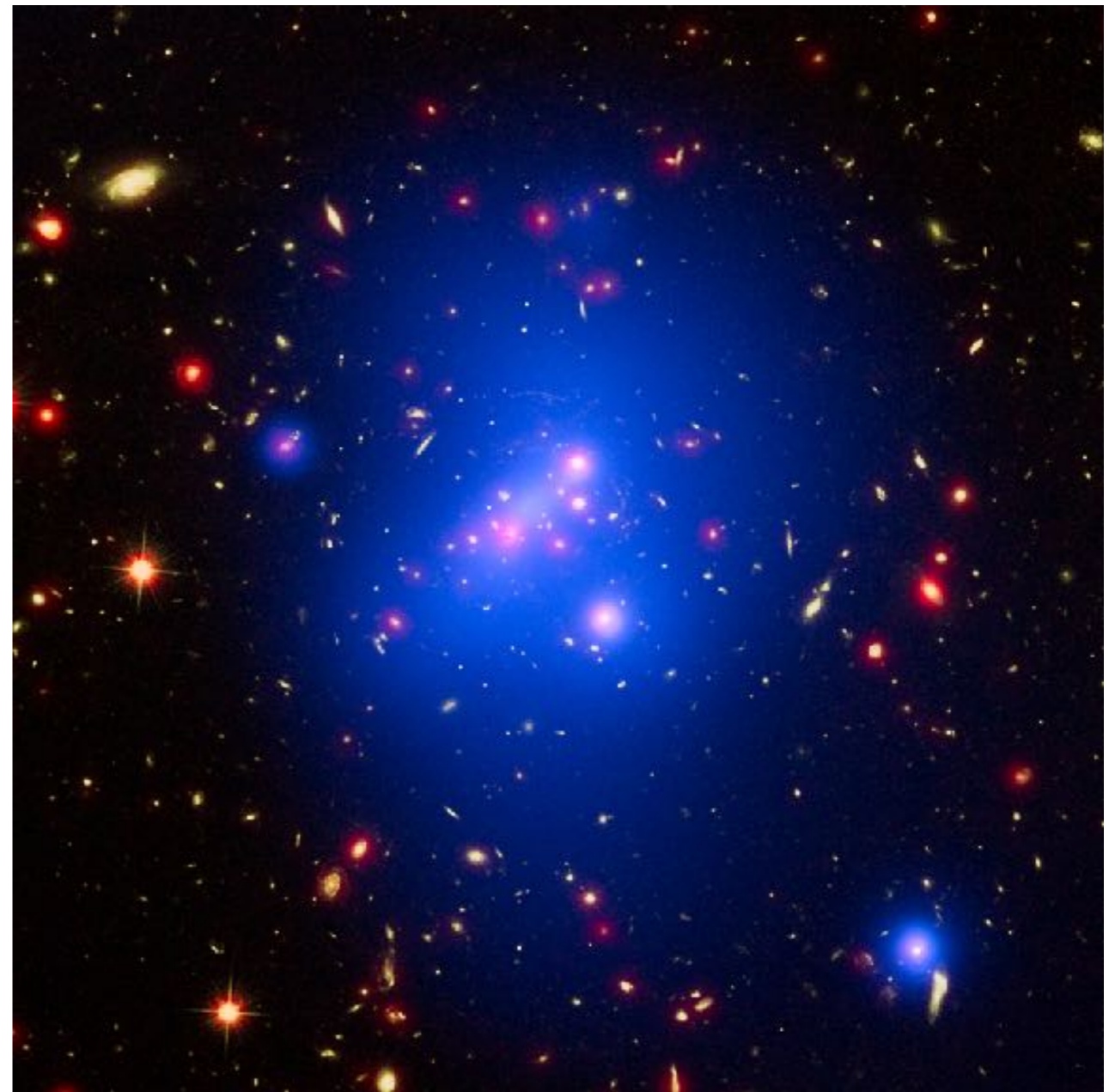

Galaxy Clusters

- Fritz Zwicky was the first to suggest “invisible” mass in clusters in the 1930s.
- He found that the orbital speeds of galaxies were too fast for the structures to stay bound without more invisible (in optical at least) gravitating mass.
- We now see the ICM in X-rays, but only see the influence of dark matter.



Fritz Zwicky

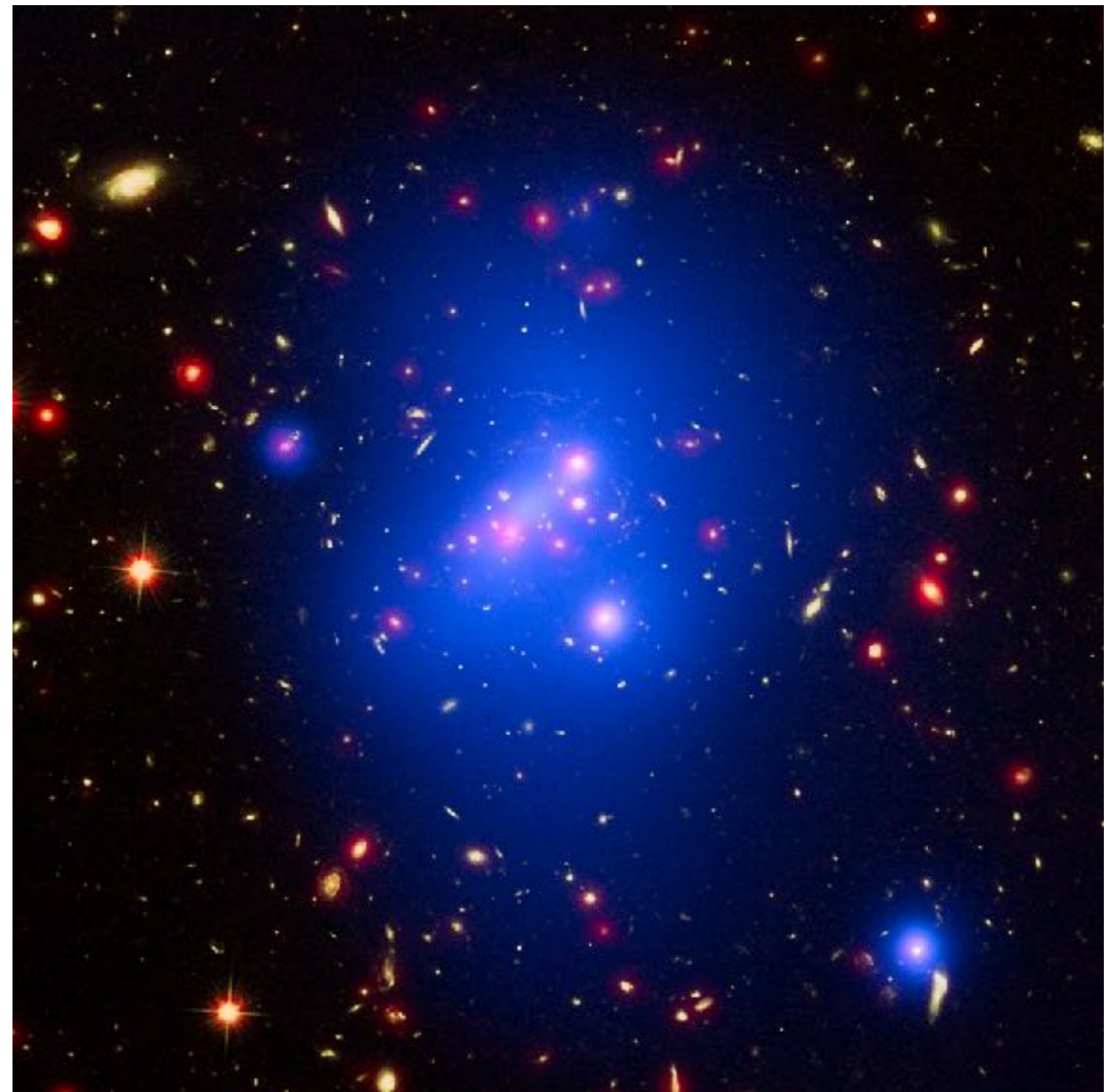

Galaxy Clusters

- Fritz Zwicky was the first to suggest “invisible” mass in clusters in the 1930s.
- He found that the orbital speeds of galaxies were too fast for the structures to stay bound without more invisible (in optical at least) gravitating mass.
- We now see the ICM in X-rays, but only see the influence of dark matter.
- We also infer DM from gravitational lensing of background galaxies (Zwicky also suggested this)



Fritz Zwicky

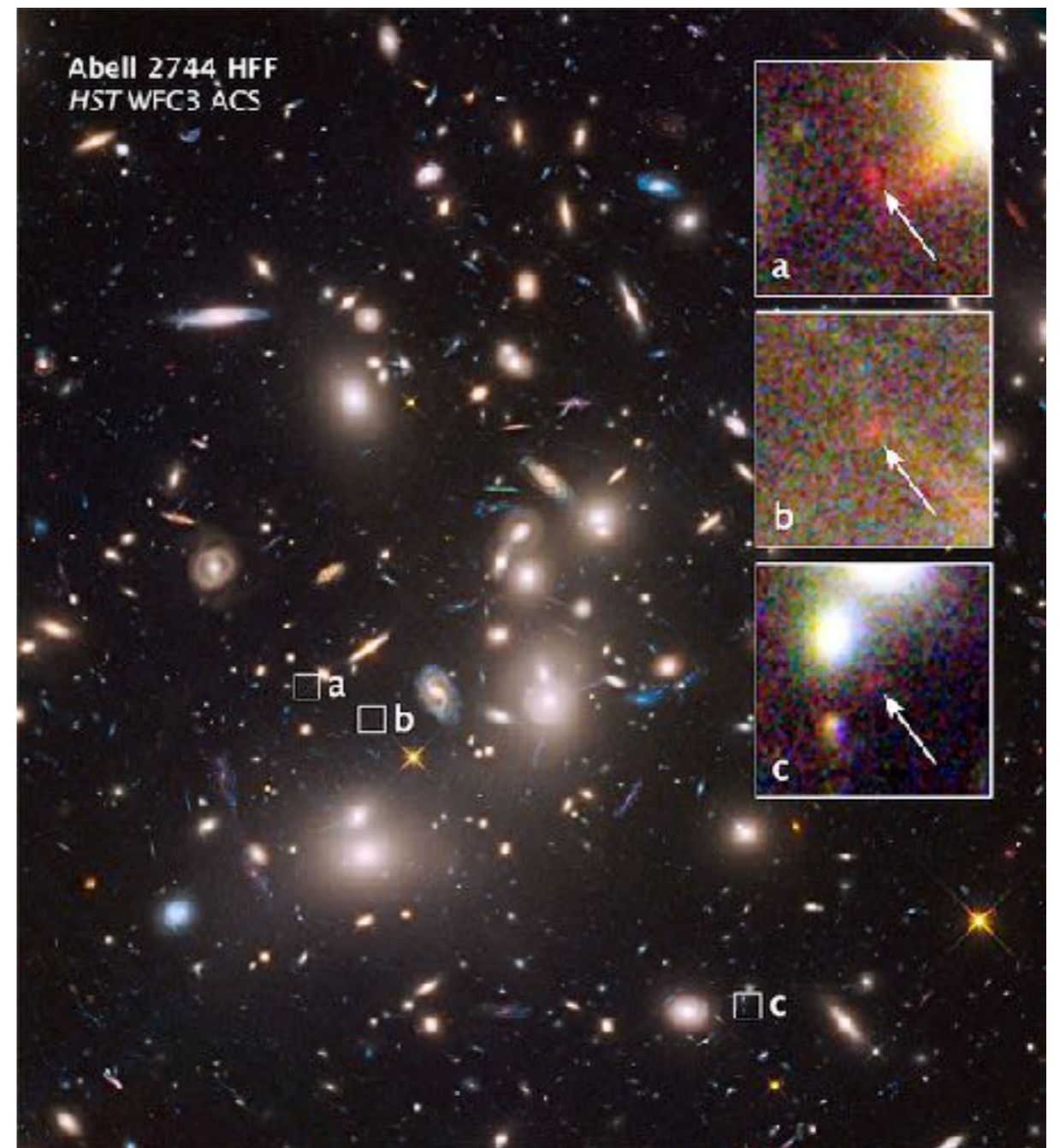

The Intra Cluster Medium

- Plasma particles in the ICM have large random thermal motions, preventing gravitational collapse in the cluster's potential well.
- In equilibrium, we can estimate the temperature from the viral theorem:
Thermal energy = (1/2) gravitational potential energy
- Ignoring some pre-factors of order unity, gives:

$$k_B T_e = k_B T_i \sim \frac{GMm_H}{R}$$

M = total cluster mass

R = radius of cluster

T_e = electron temp

T_i = ion temp

m_H = mass of hydrogen atom

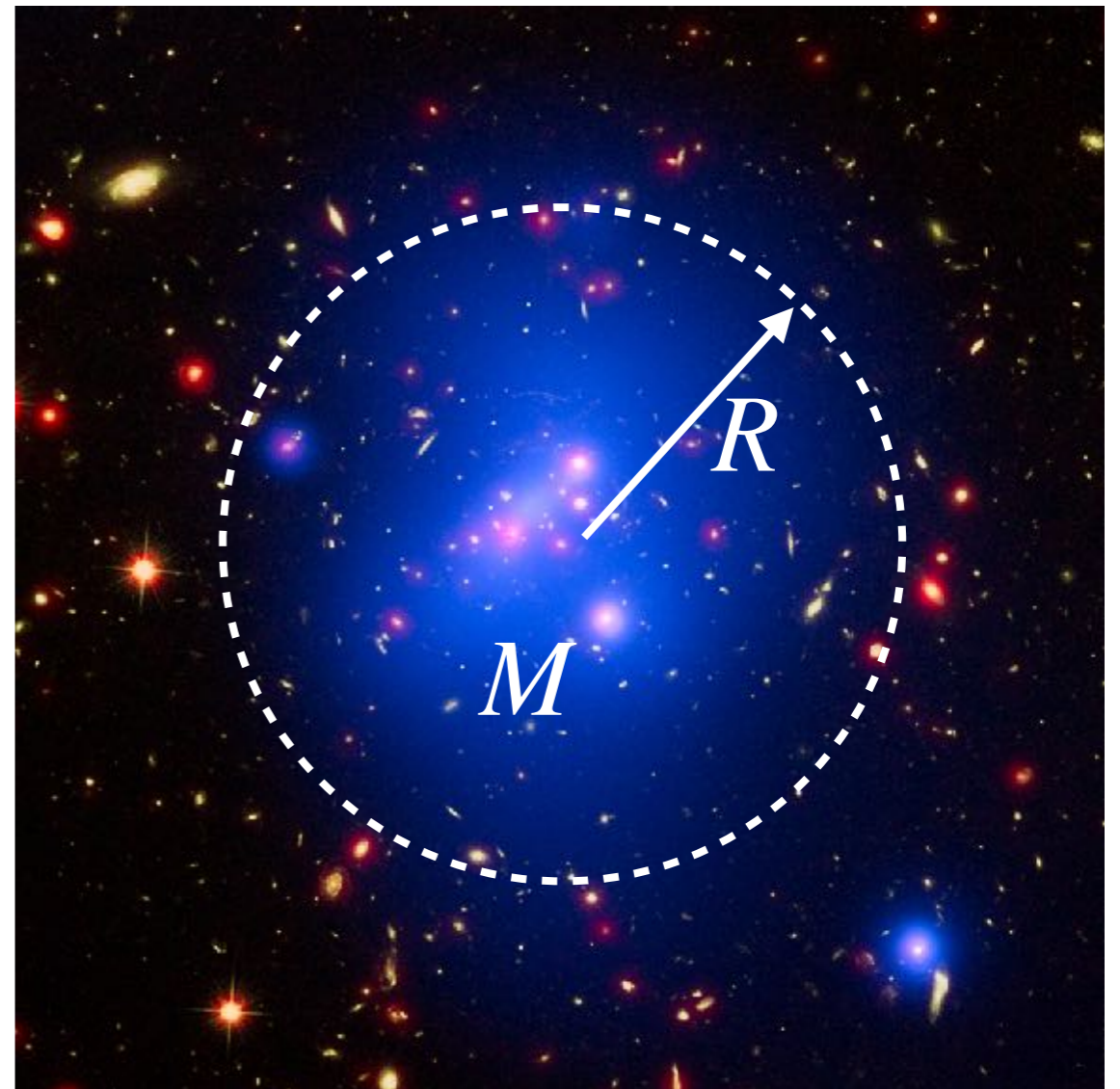

The Intra Cluster Medium

- ICM is thermalised; i.e. electrons have Maxwellian velocity distribution.
- BUT plasma density is too low for blackbody radiation (i.e. photons are not in thermal equilibrium with electrons).
- Dominant emission mechanism: thermal bremsstrahlung radiation.

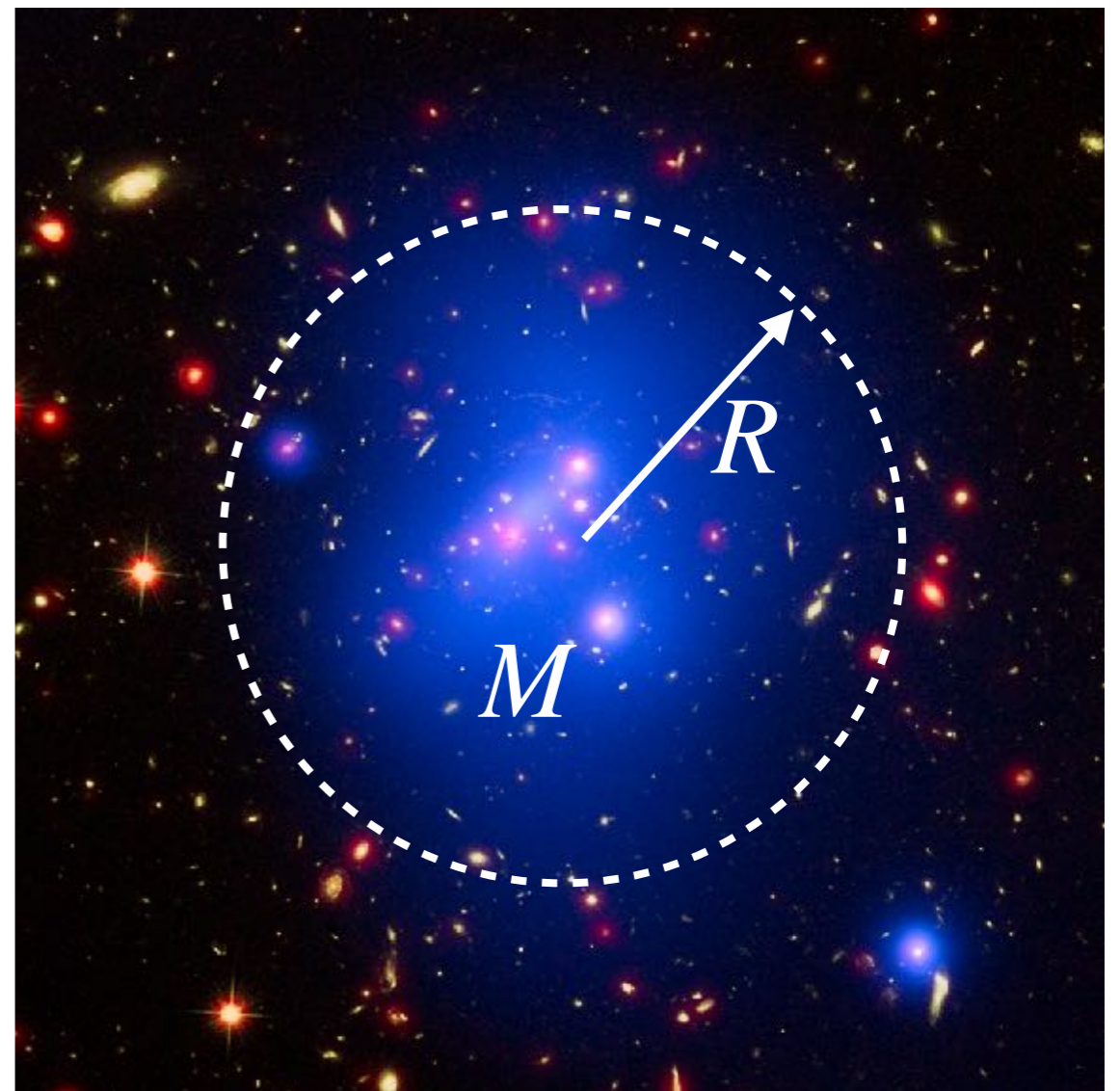

Bremsstrahlung

- Bremsstrahlung radiation = “Breaking radiation”
- Electron moving at velocity v on a trajectory to miss an ion by a distance b .
- b = the impact parameter.
- Coulomb force will accelerate the electron towards the ion.
- Power of EM radiation given by Larmor formula.
- i.e. like synchrotron, except an ion deflects the electron instead of a magnetic field.

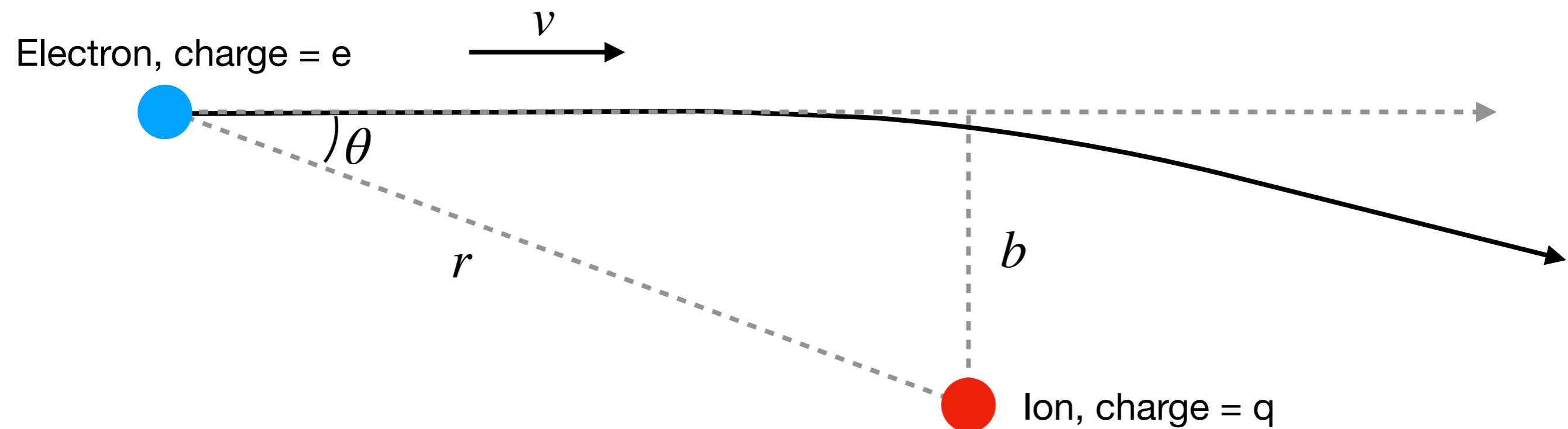

Bremsstrahlung

- Vertical acceleration from Coulomb formula:

$$a_z = - \frac{qe}{4\pi m_e \epsilon_0 r^2} \sin \theta$$

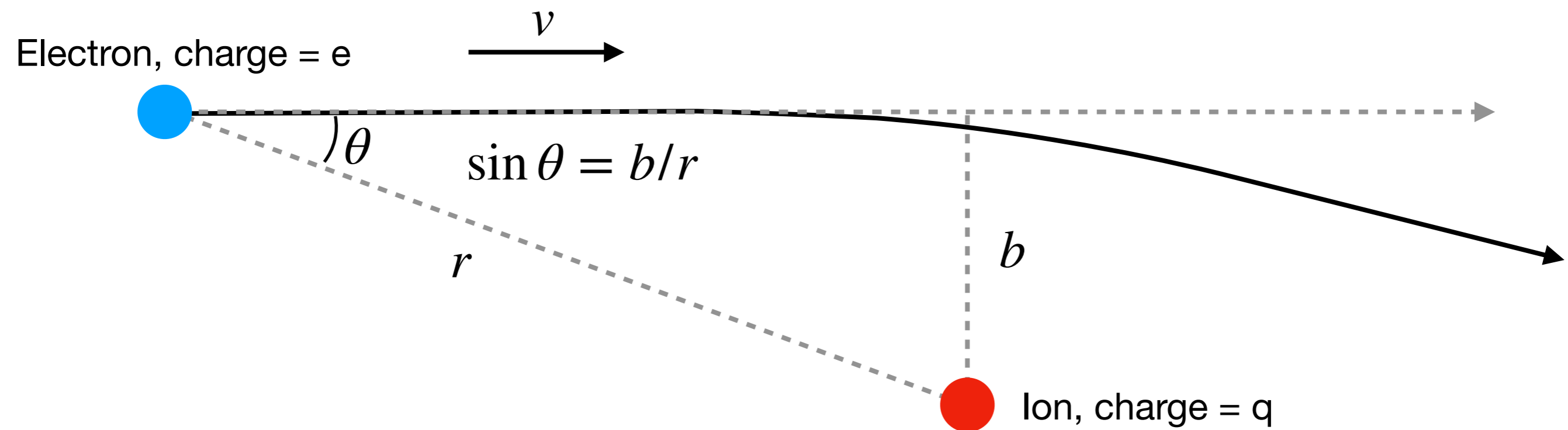

Bremsstrahlung

- Vertical acceleration from Coulomb formula:

$$a_z = - \frac{qe}{4\pi m_e \epsilon_0 r^2} \sin \theta$$

- Replace r with b: $r = b/\sin \theta$

$$\implies a_z = - \frac{qe}{4\pi m_e \epsilon_0 b^2} \sin^3 \theta$$

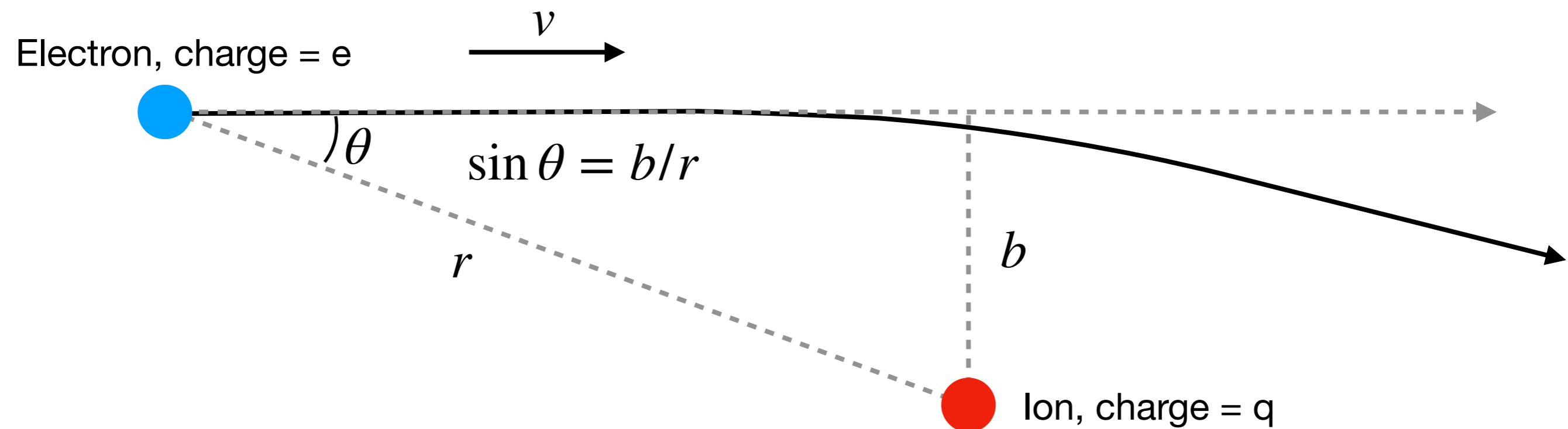

Bremsstrahlung

- Vertical acceleration from Coulomb formula:

$$a_z = - \frac{qe}{4\pi m_e \epsilon_0 r^2} \sin \theta$$

- Replace r with b: $r = b/\sin \theta$

$$\implies a_z = - \frac{qe}{4\pi m_e \epsilon_0 b^2} \sin^3 \theta$$

- Ignore horizontal acceleration (acceleration before collision, deceleration after)

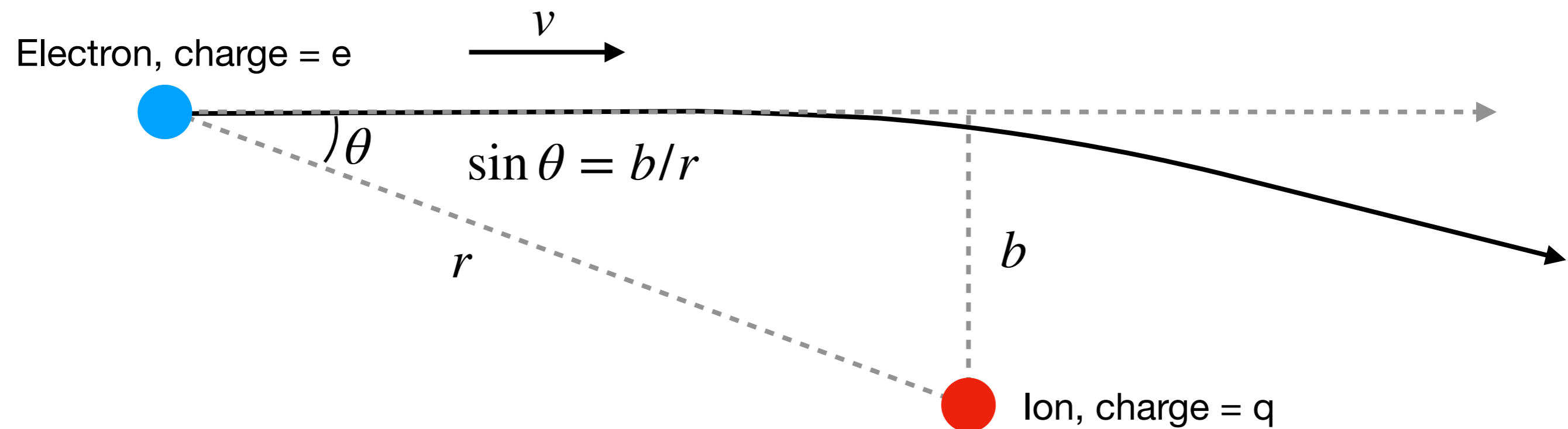

Bremsstrahlung

$$a_z = - \frac{qe}{4\pi m_e \epsilon_0 b^2} \sin^3 \theta$$

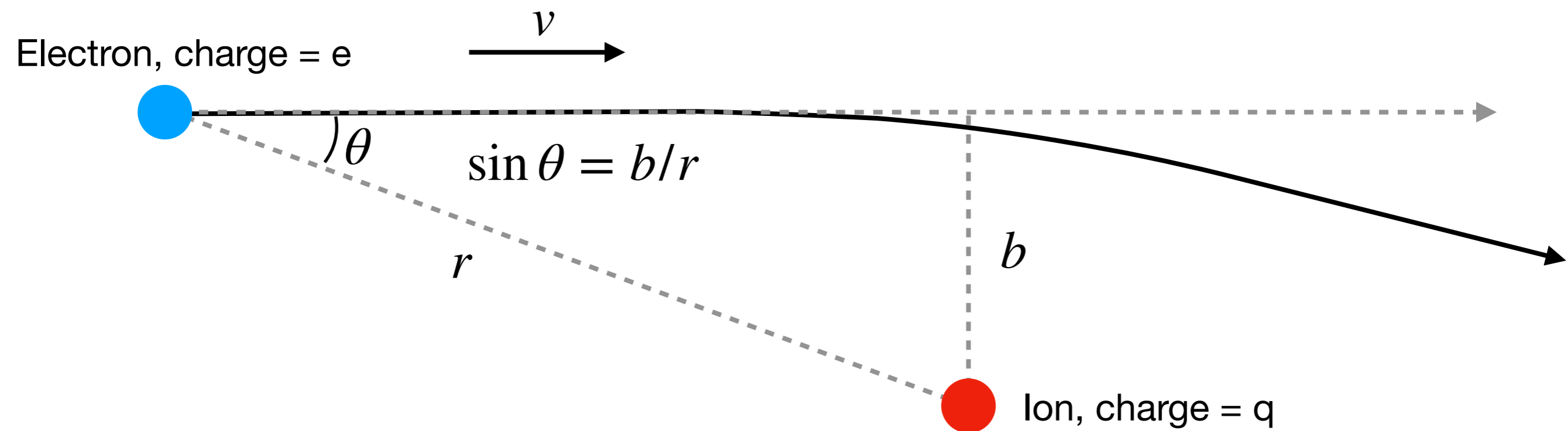

Bremsstrahlung

$$a_z = -\frac{qe}{4\pi m_e \epsilon_0 b^2} \sin^3 \theta$$

- Radiation power (Larmor formula derived in lecture 3):

$$P = \frac{e^2 a^2}{6\pi \epsilon_0 c^3}$$

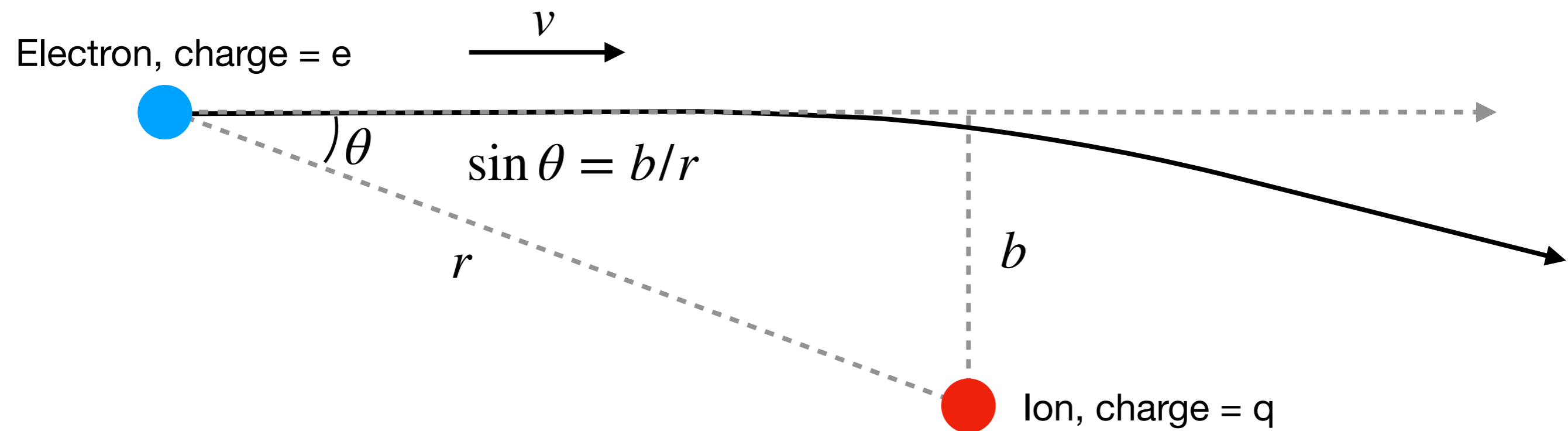

Bremsstrahlung

$$a_z = -\frac{qe}{4\pi m_e \epsilon_0 b^2} \sin^3 \theta$$

- Radiation power (Larmor formula derived in lecture 3):

$$P = \frac{e^2 a^2}{6\pi \epsilon_0 c^3}$$

- Sub in:

$$\implies P = \frac{q^2 e^4}{96\pi^3 m_e^2 \epsilon_0^3 b^4 c^3} \sin^6 \theta$$

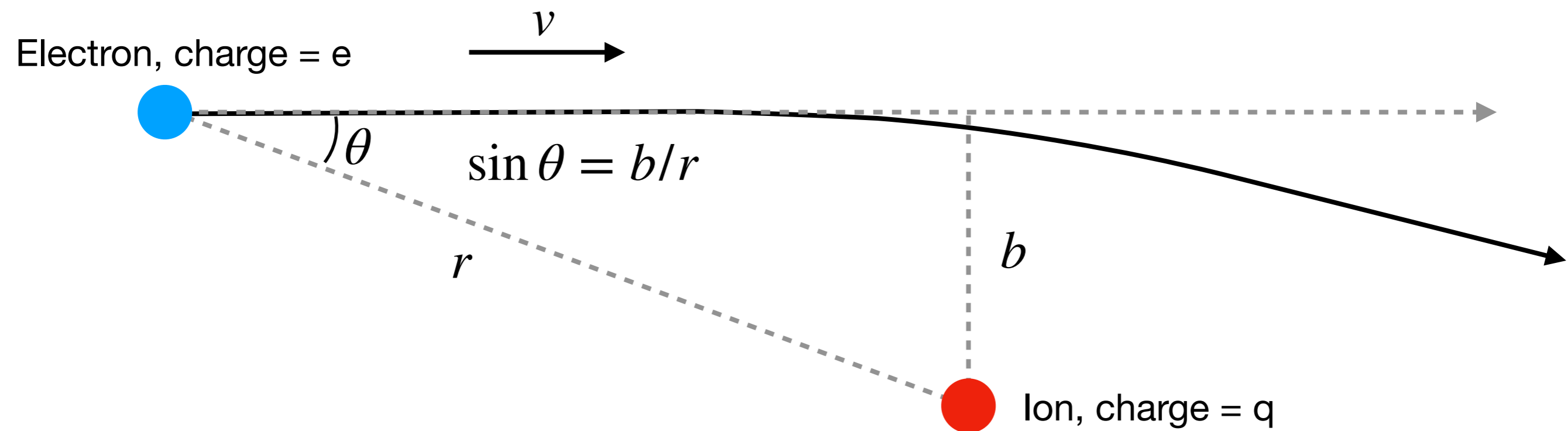

Bremsstrahlung

$$a_z = -\frac{qe}{4\pi m_e \epsilon_0 b^2} \sin^3 \theta$$

- Radiation power (Larmor formula derived in lecture 3):

$$P = \frac{e^2 a^2}{6\pi \epsilon_0 c^3}$$

- Sub in:

$$\implies P = \frac{q^2 e^4}{96\pi^3 m_e^2 \epsilon_0^3 b^4 c^3} \sin^6 \theta$$

- Thomson cross-section:

$$\sigma_T = \frac{1}{6\pi} \left(\frac{e^2}{\epsilon_0 m_e c^2} \right)^2$$

$$\implies P = \frac{q^2 \sigma_T c}{16\pi^2 \epsilon_0 b^4} \sin^6 \theta$$

Bremsstrahlung

- Solve equation of motion to get $P(t)$. Hard in general but get a feel by ignoring vertical motion of electron: $x(t) = vt$
- v is constant and $x=0$ when $t=0$.
- In this case: $\tan[\theta(t)] = b/x(t)$; $P(t) \propto \sin^6[\theta(t)]$

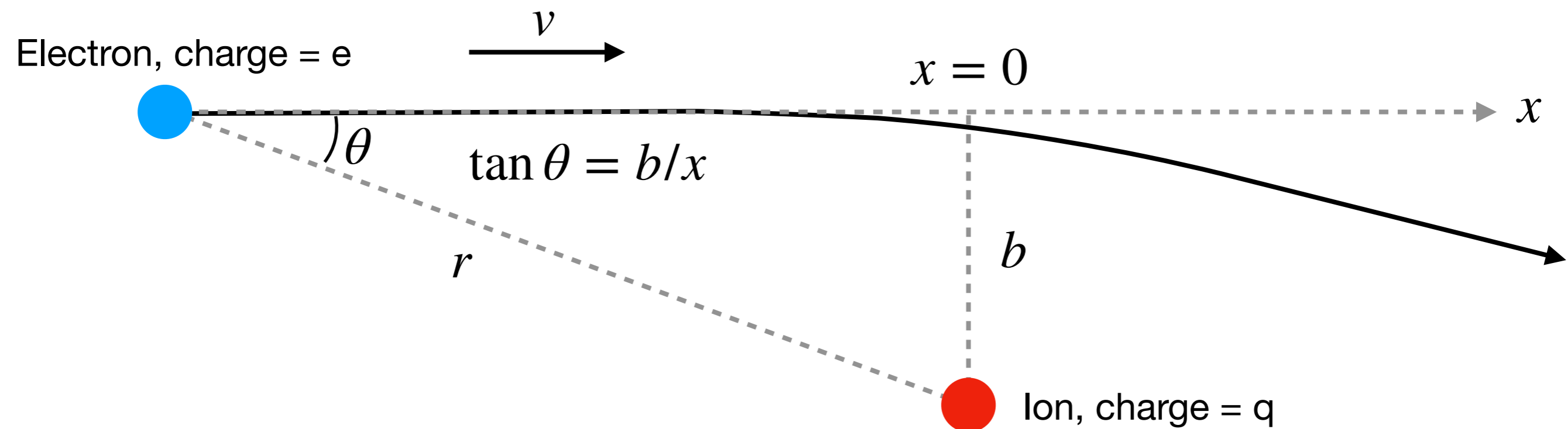

Bremsstrahlung

- Solve equation of motion to get $P(t)$. Hard in general but get a feel by ignoring vertical motion of electron: $x(t) = vt$
- v is constant and $x=0$ when $t=0$.
- In this case: $\tan[\theta(t)] = b/x(t)$; $P(t) \propto \sin^6[\theta(t)]$

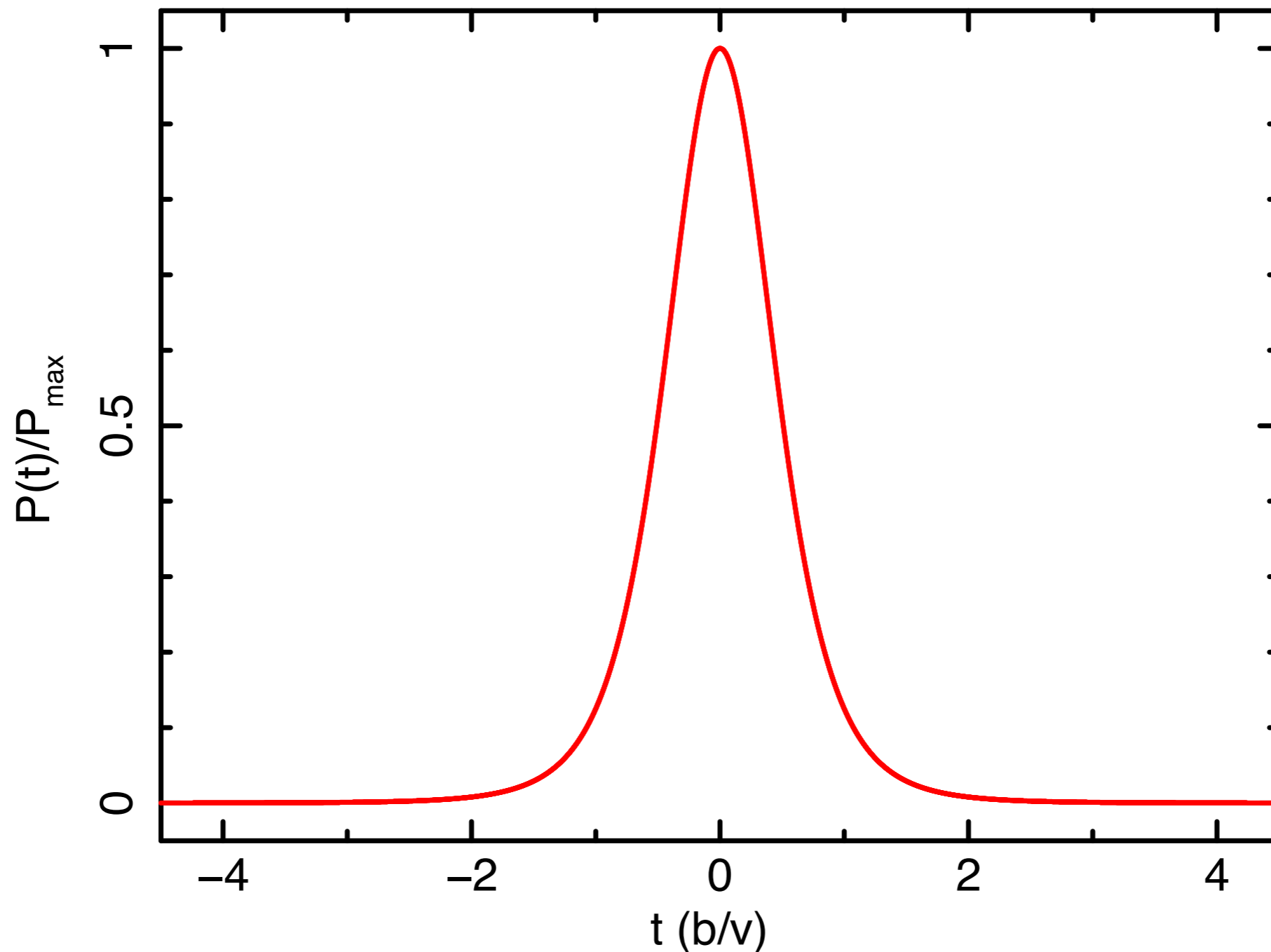

Bremsstrahlung

- To get the spectrum, we need the same trick we used for synchrotron radiation: take the Fourier transform

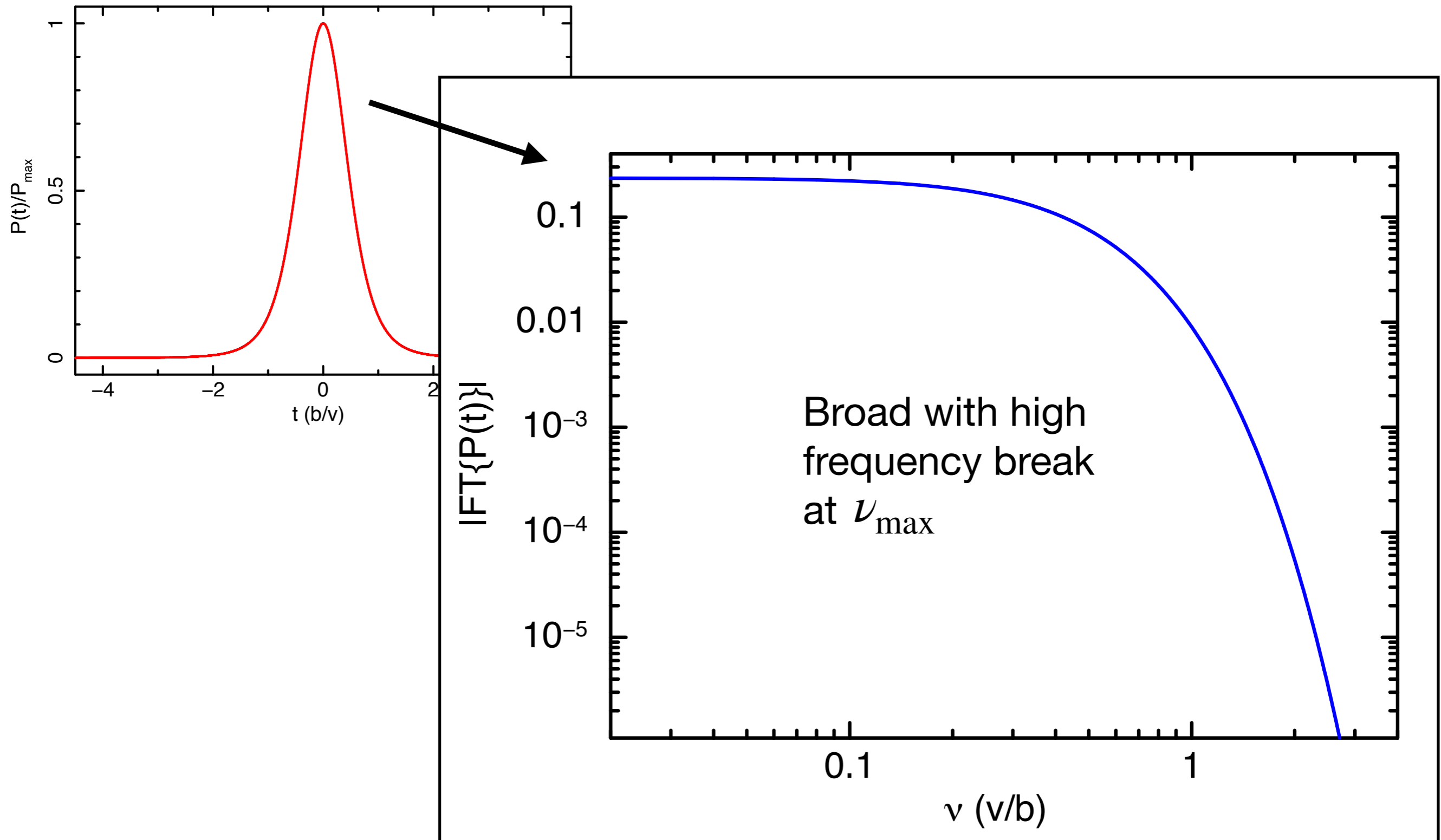

Bremsstrahlung

- Can estimate the break frequency by appreciating that most of the energy in the pulse is irradiated between $\theta = \pi/4$ and $\theta = 3\pi/4$

$$\frac{\int_{\pi/4}^{\pi/2} \sin^6 \theta d\theta}{\int_0^{\pi/2} \sin^6 \theta d\theta} > 0.96$$

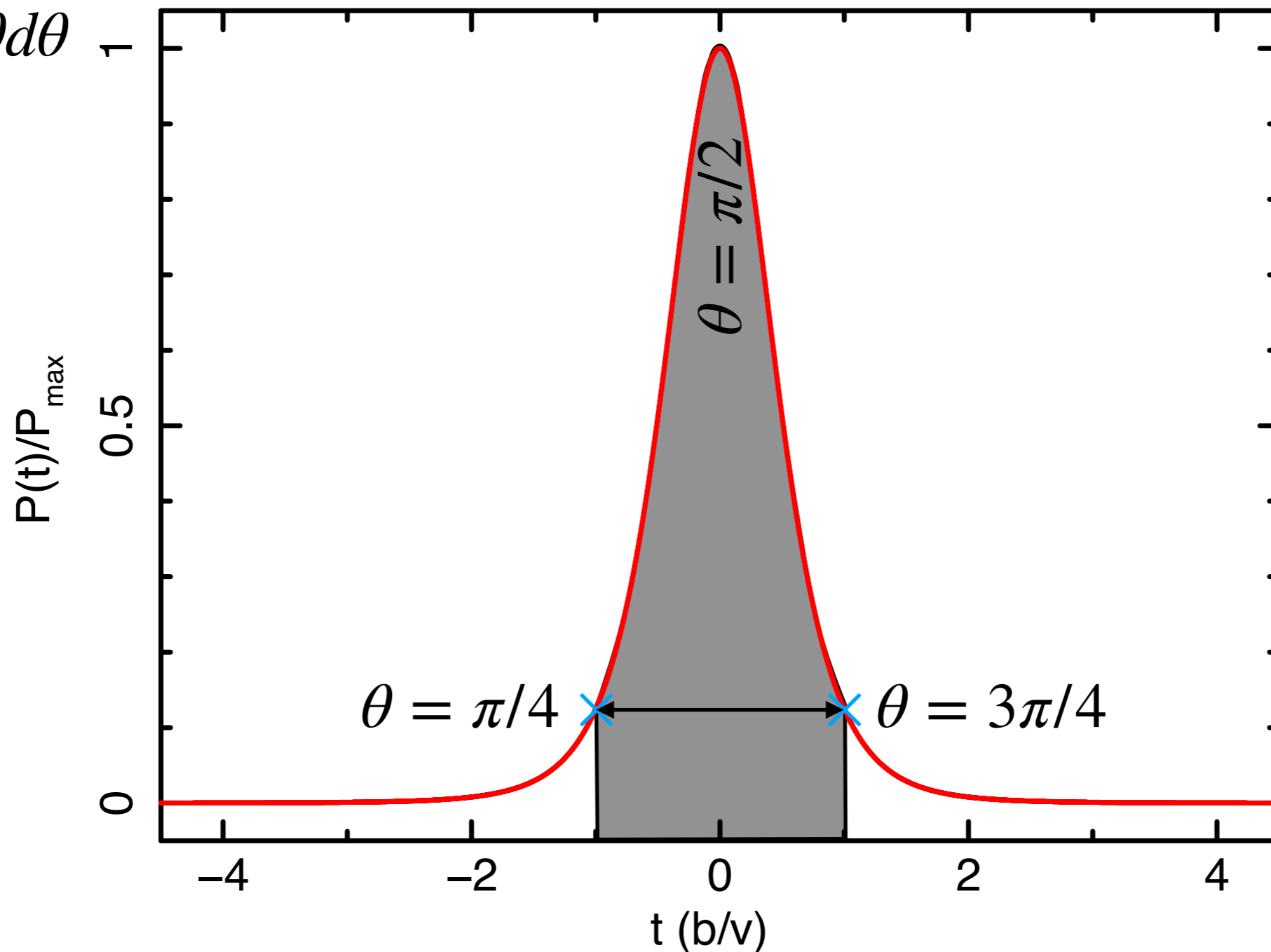

Bremsstrahlung

- Can estimate the break frequency by appreciating that most of the energy in the pulse is irradiated between $\theta = \pi/4$ and $\theta = 3\pi/4$
- Corresponds to $\tan \theta = \pm 1$
- Therefore pulse is \sim a top hat with duration $\Delta t = 2b/v$

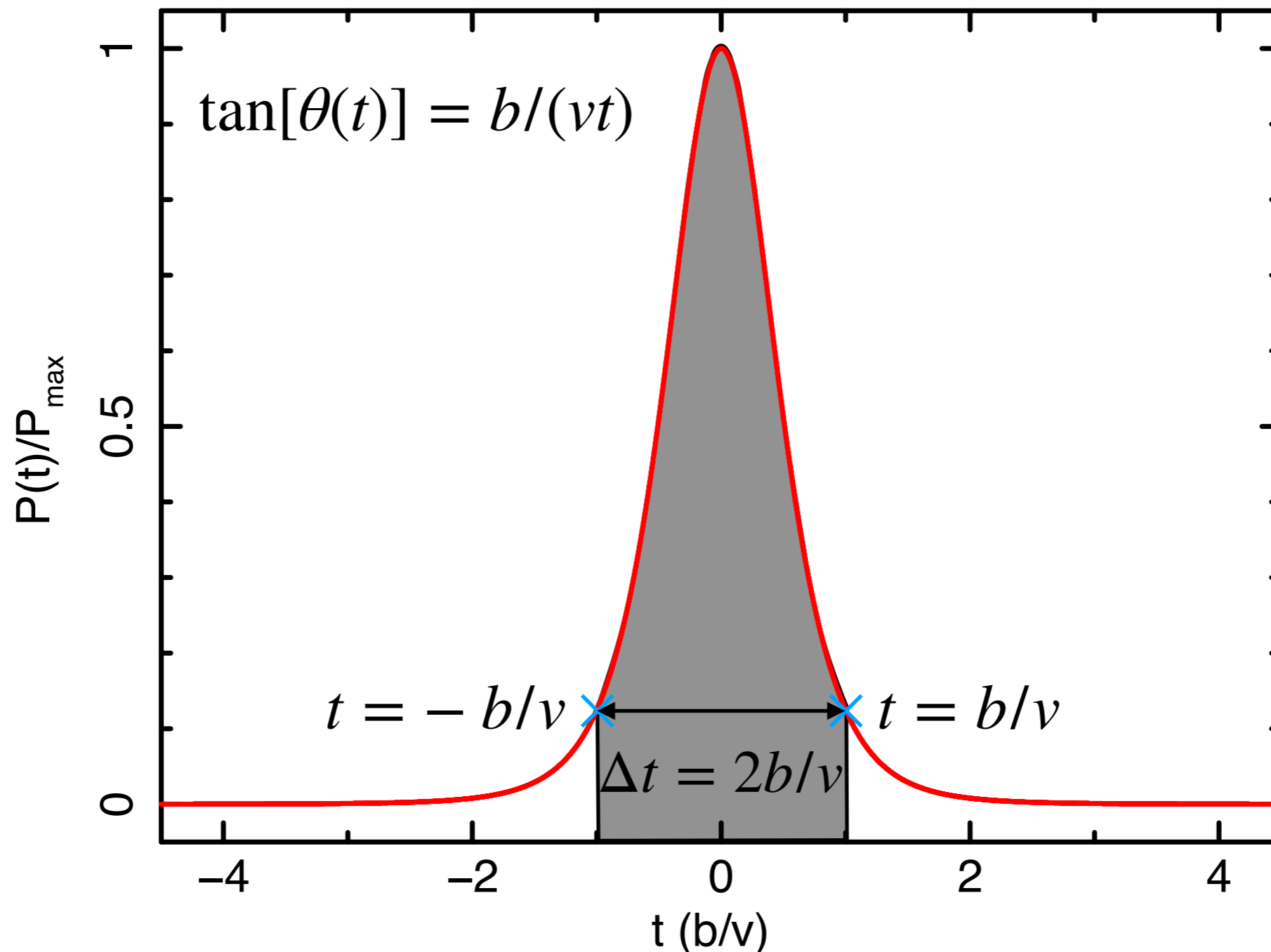

Bremsstrahlung

- To get the spectrum, we need the same trick we used for synchrotron radiation: take the Fourier transform

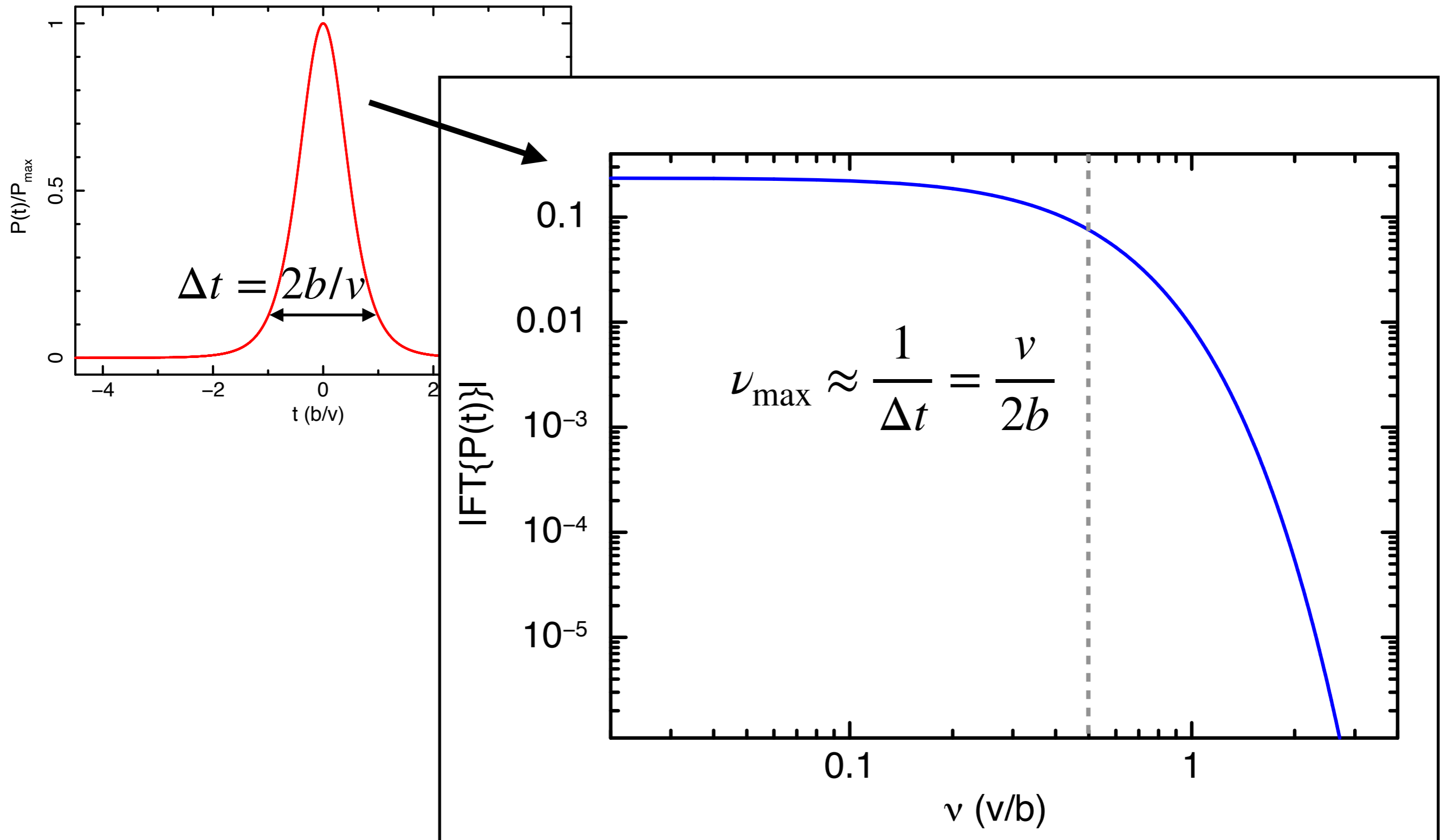

Bremsstrahlung

- Approximate spectrum as constant below ν_{\max} and zero above.

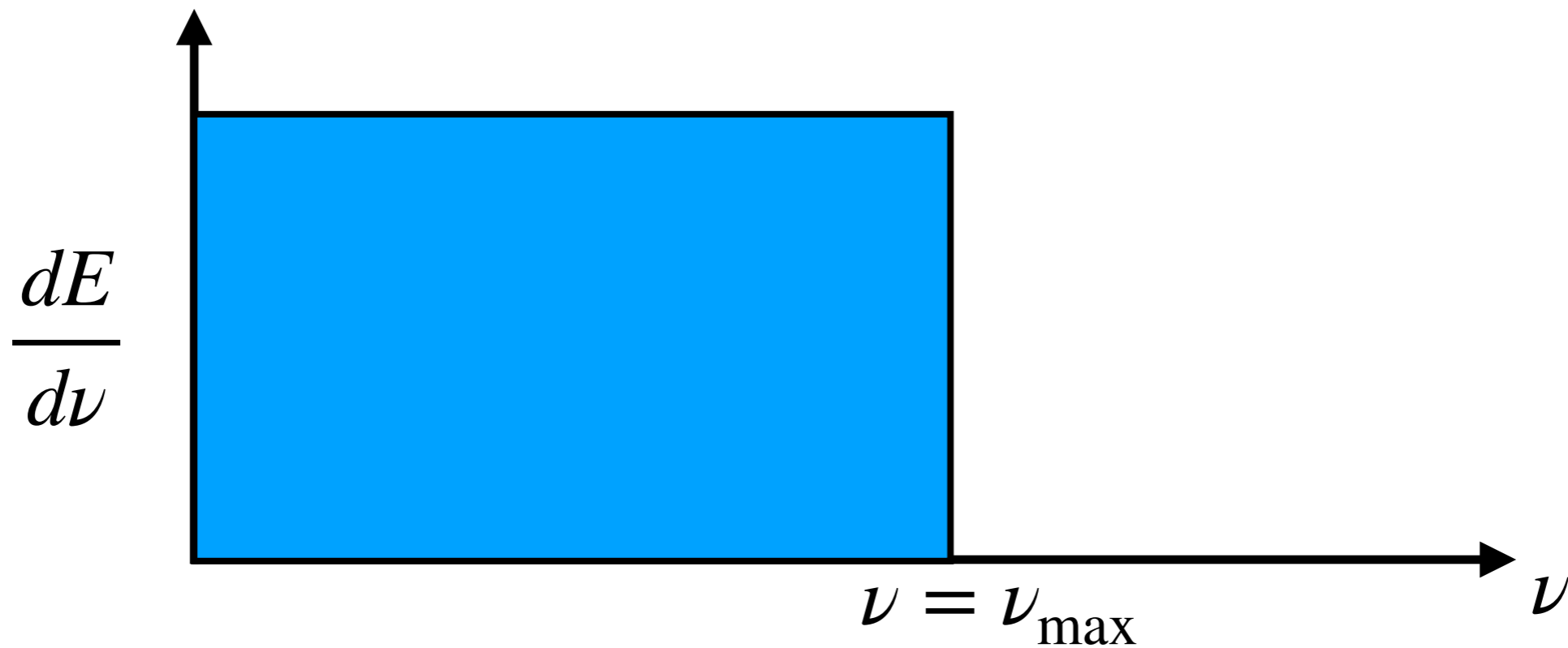

Bremsstrahlung

- Approximate spectrum as constant below ν_{\max} and zero above.
- Total energy in the pulse:

$$E = \int_0^{\infty} \frac{dE}{d\nu} d\nu = \int_{-\infty}^{\infty} P(t) dt \approx P_{\max} \Delta t$$

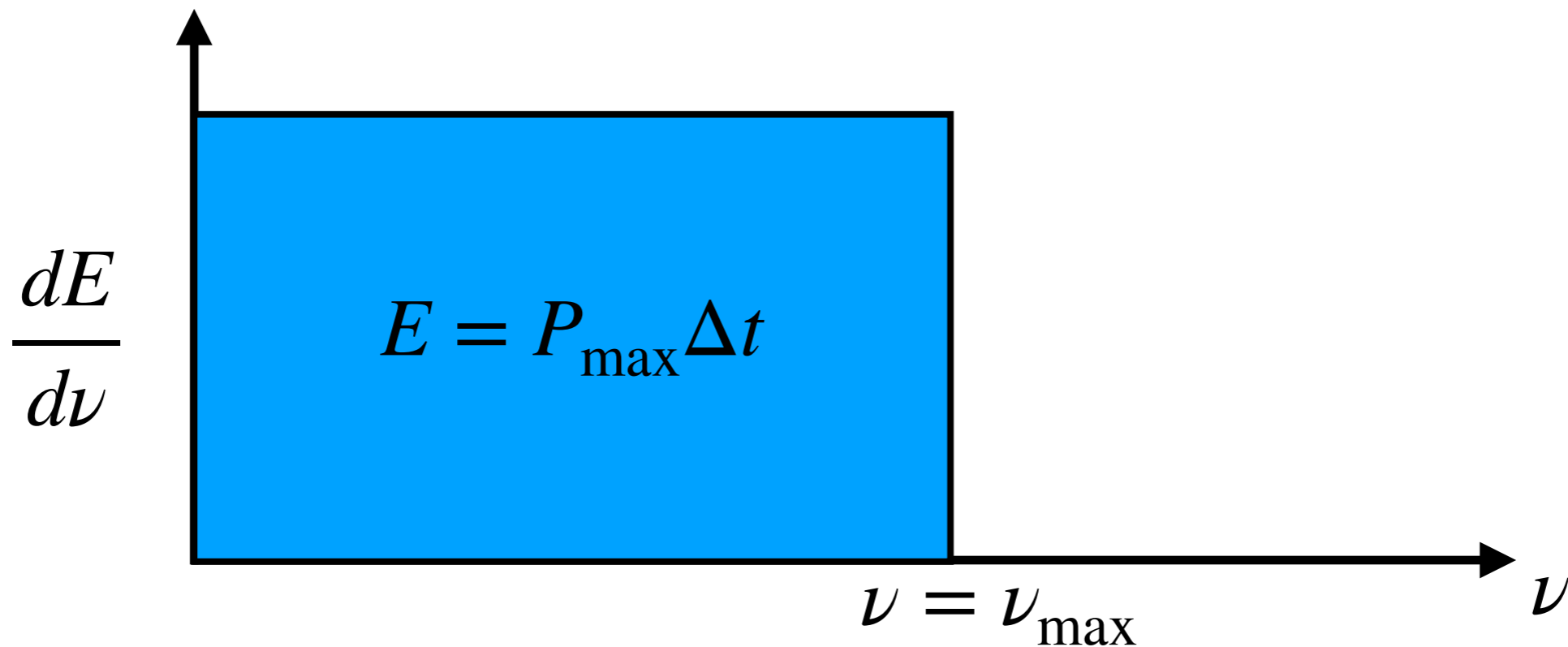

Bremsstrahlung

- Approximate spectrum as constant below ν_{\max} and zero above.
- Total energy in the pulse:

$$E = \int_0^{\infty} \frac{dE}{d\nu} d\nu = \int_{-\infty}^{\infty} P(t) dt \approx P_{\max} \Delta t$$

- Therefore energy radiated per unit frequency (per event):

$$\frac{dE}{d\nu} \approx \frac{d}{d\nu} [P_{\max} \Delta t]$$

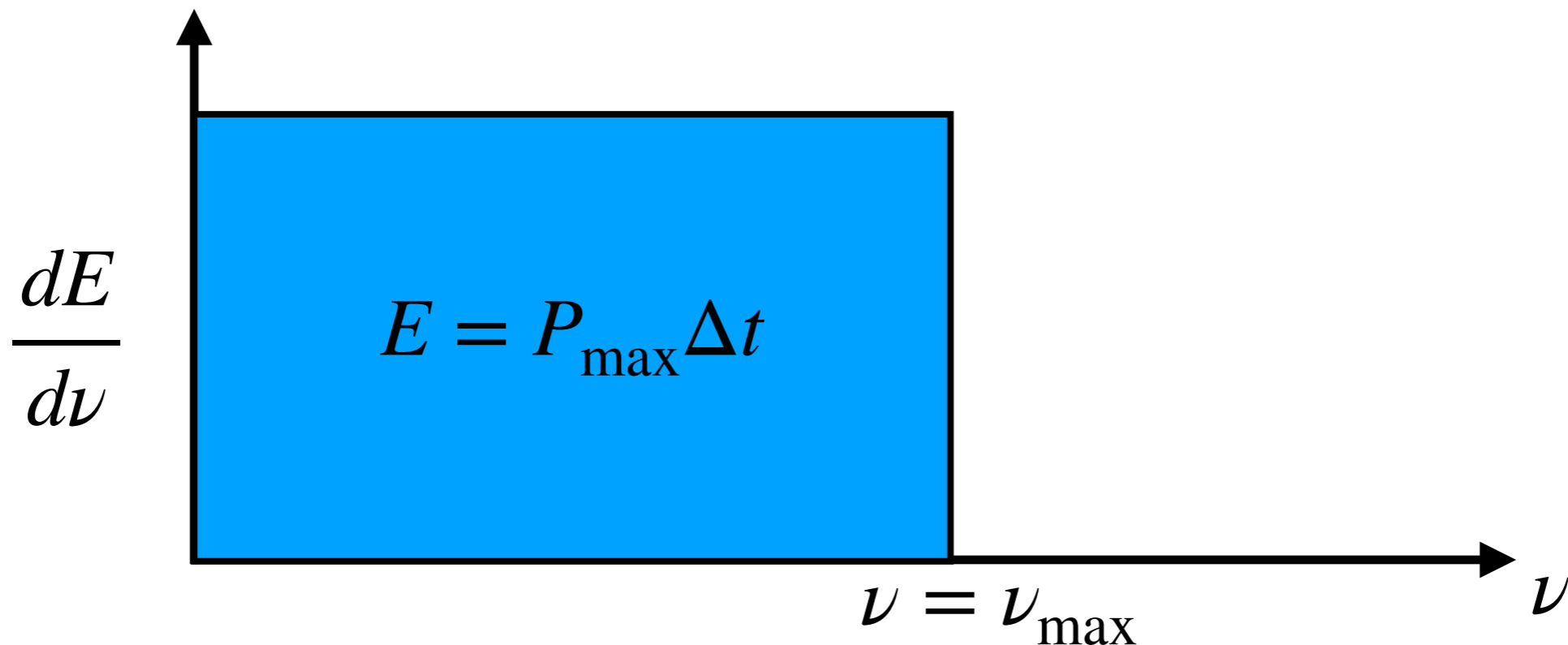

Bremsstrahlung

- Approximate spectrum as constant below ν_{\max} and zero above.
- Total energy in the pulse:

$$E = \int_0^{\infty} \frac{dE}{d\nu} d\nu = \int_{-\infty}^{\infty} P(t) dt \approx P_{\max} \Delta t$$

- Therefore energy radiated per unit frequency (per event):

$$\frac{dE}{d\nu} \approx \frac{d}{d\nu} [P_{\max} \Delta t] \approx \frac{P_{\max} \Delta t}{\nu_{\max}} = P_{\max} (\Delta t)^2$$

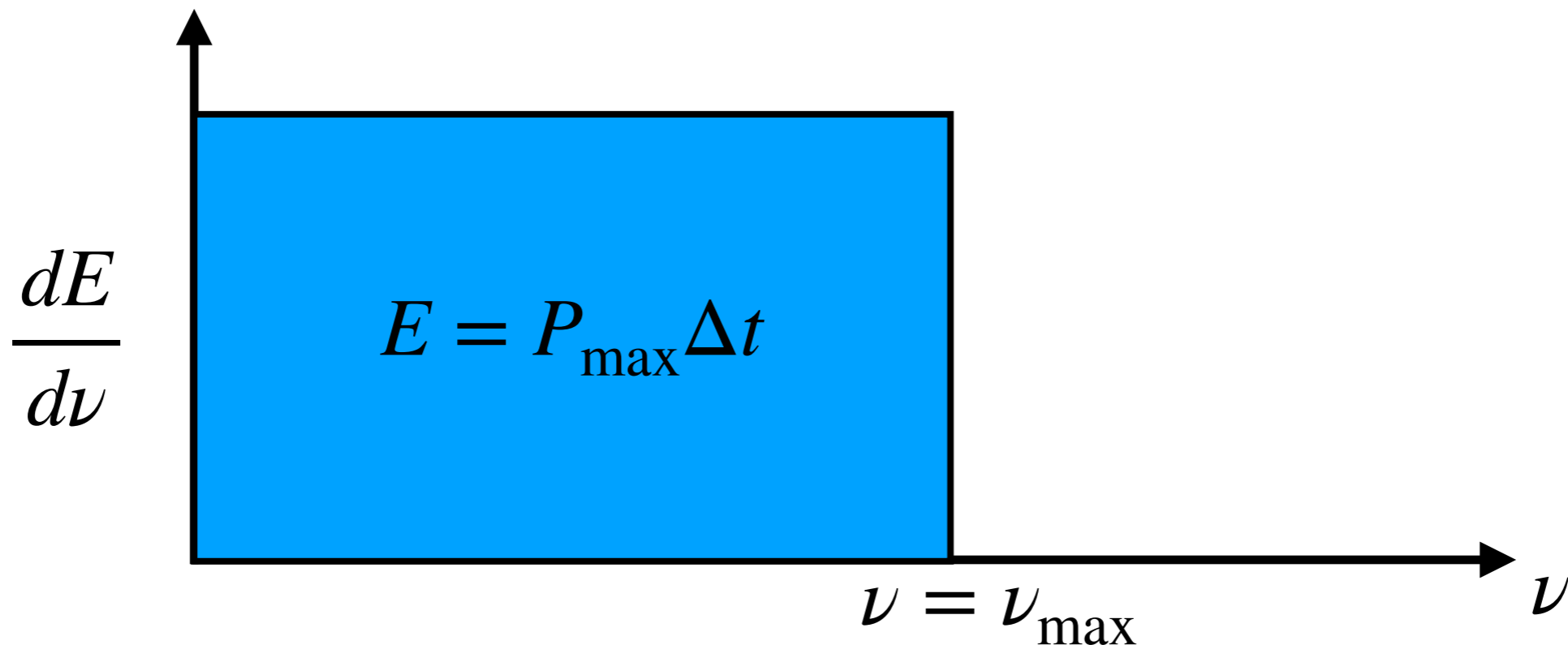

Bremsstrahlung

- Approximate spectrum as constant below ν_{\max} and zero above.
- Total energy in the pulse:

$$E = \int_0^{\infty} \frac{dE}{d\nu} d\nu = \int_{-\infty}^{\infty} P(t) dt \approx P_{\max} \Delta t$$

- Therefore energy radiated per unit frequency (per event):

$$\frac{dE}{d\nu} \approx \frac{d}{d\nu} [P_{\max} \Delta t] \approx \frac{P_{\max} \Delta t}{\nu_{\max}} = P_{\max} (\Delta t)^2$$

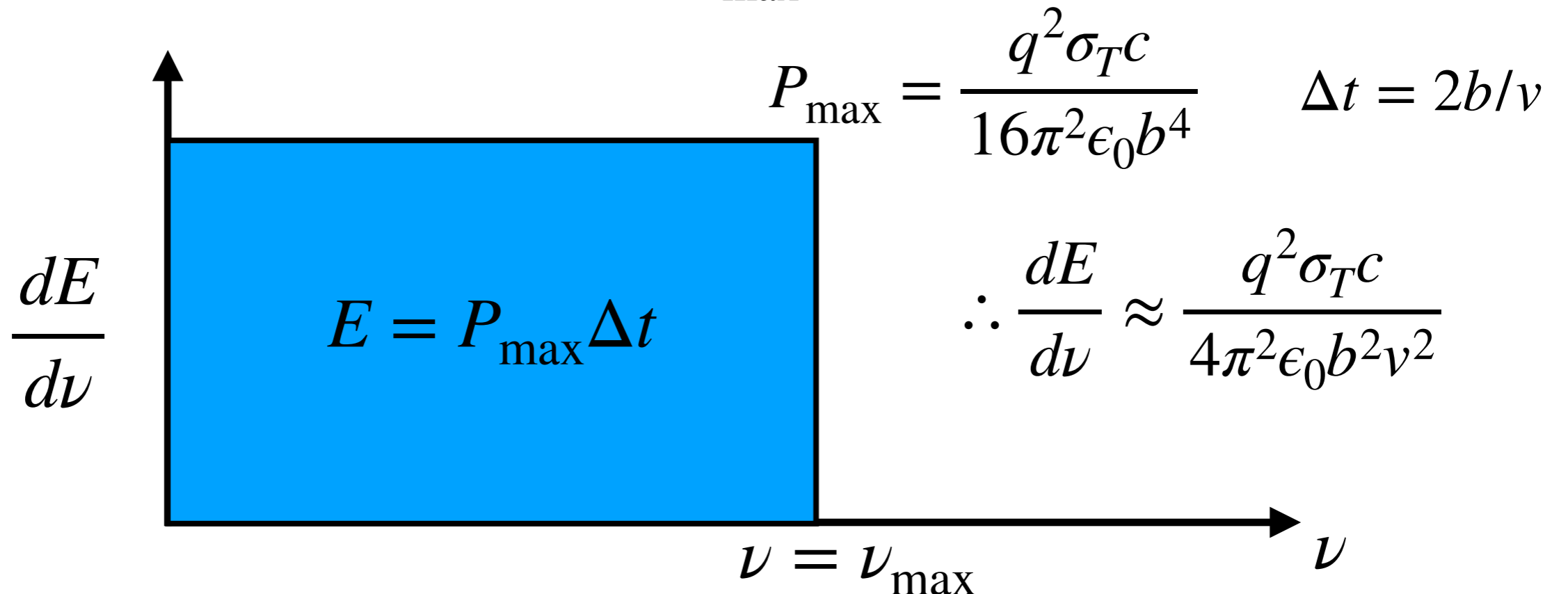

Bremsstrahlung

- This is the spectrum for a single event, whereby the electron has a particular speed v and impact parameter b .

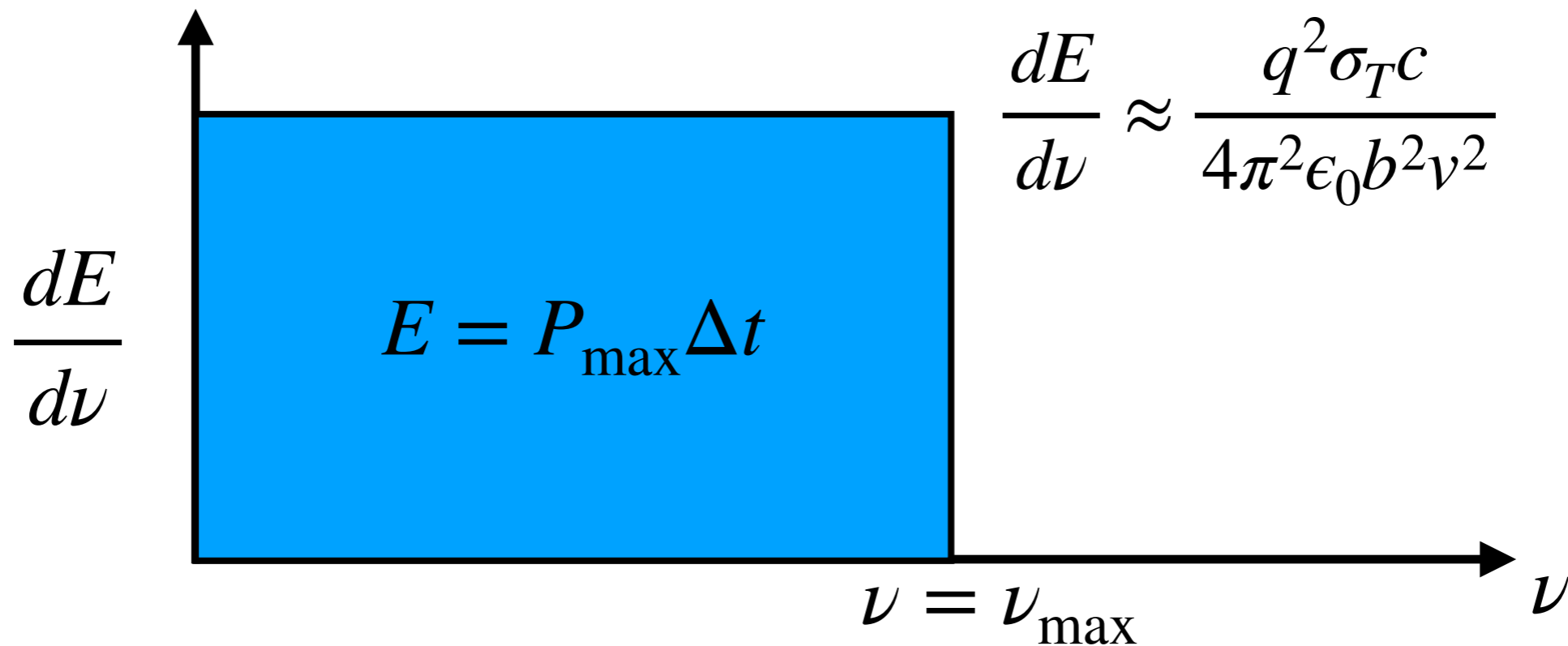

Bremsstrahlung

- This is the spectrum for a single event, whereby the electron has a particular speed v and impact parameter b .
- We need the overall spectrum for the whole velocity distribution, integrated over all impact parameters.
- Number of collisions with impact parameter between b and $b+db$ that a given ion will have is:

$$\frac{dN}{dt} = n_e v 2\pi b db$$

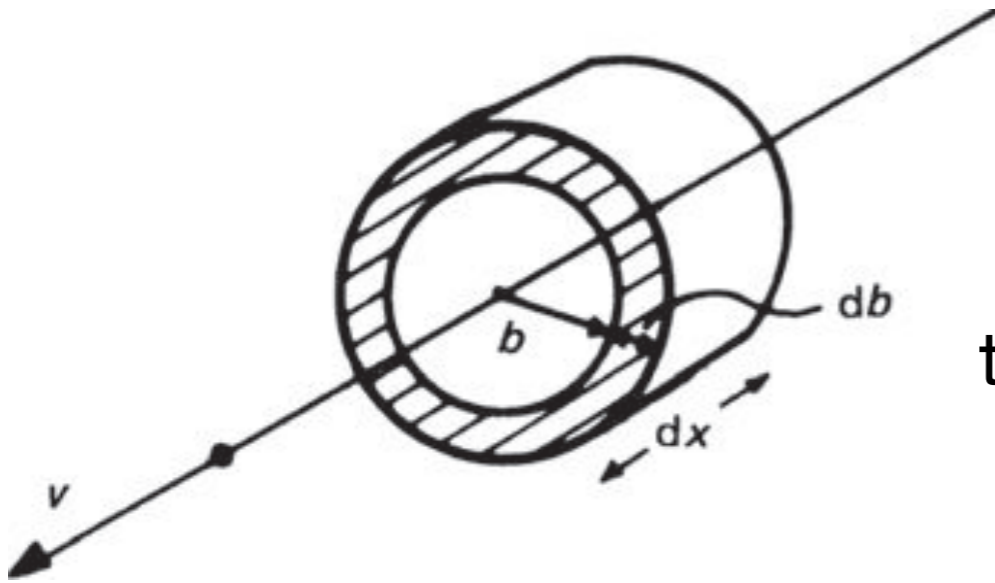

In time interval dt , the volume swept out by this range of impact parameters is $2\pi b db dx$.
Volume swept out per unit time is $2\pi b db v$.

Bremsstrahlung

- This is the spectrum for a single event, whereby the electron has a particular speed v and impact parameter b .
- We need the overall spectrum for the whole velocity distribution, integrated over all impact parameters.
- Number of collisions with impact parameter between b and $b+db$ that a given ion will have is:

$$\frac{dN}{dt} = n_e v 2\pi b db$$

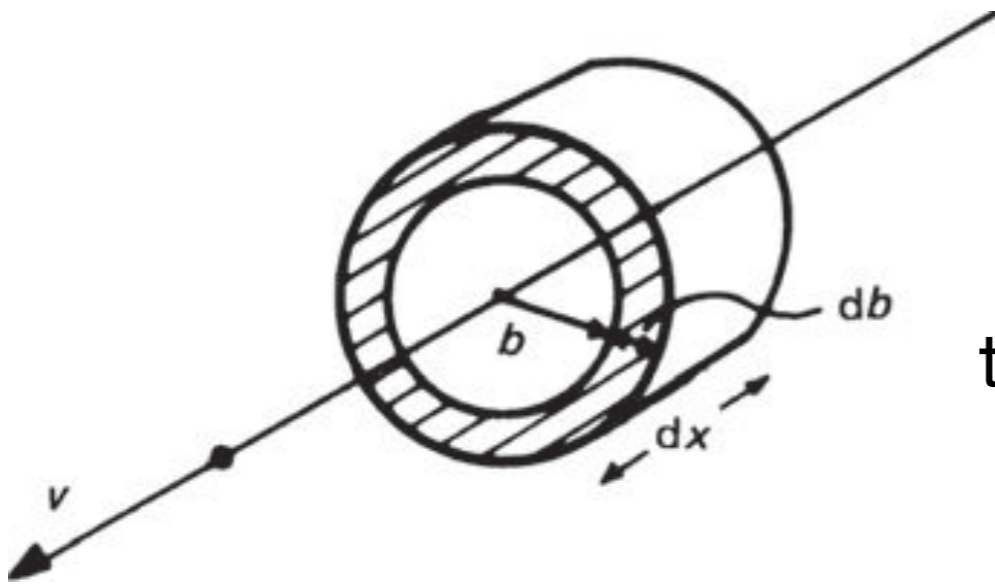

In time interval dt , the volume swept out by this range of impact parameters is $2\pi b db dx$.
Volume swept out per unit time is $2\pi b db v$.

- Total number of collisions per unit time per unit volume with impact parameter between b and $b+db$:

$$\frac{dN}{dV dt} = n_e n_i v 2\pi b db$$

Bremsstrahlung

- Therefore energy radiated per unit frequency per unit time per unit volume:

$$\frac{dE}{d\nu dt dV} = \int_{b_{\min}}^{b_{\max}} P_{\max} (\Delta t)^2 \cdot n_e v 2\pi b db$$

Energy per frequency
per event

Events per time per
volume

Bremsstrahlung

- Therefore energy radiated per unit frequency per unit time per unit volume:

$$\frac{dE}{d\nu dt dV} = \int_{b_{\min}}^{b_{\max}} P_{\max} (\Delta t)^2 \cdot n_e v 2\pi b db$$

Energy per frequency
per event

Events per time per
volume

- Now just need to work out limits b_{\min} and b_{\max} .

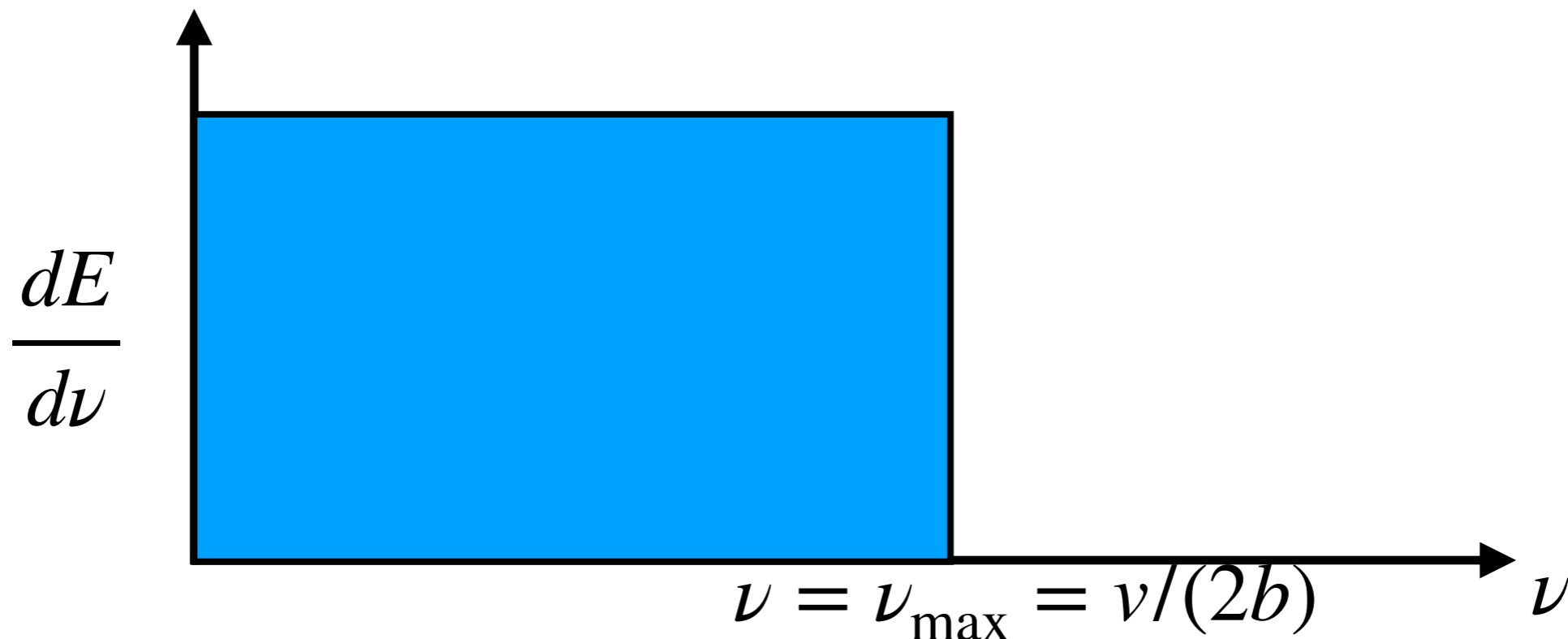

Bremsstrahlung

- Therefore energy radiated per unit frequency per unit time per unit volume:

$$\frac{dE}{d\nu dt dV} = \int_{b_{\min}}^{b_{\max}} P_{\max} (\Delta t)^2 \cdot n_e v 2\pi b db$$

Energy per frequency
per event

Events per time per
volume

- Now just need to work out limits b_{\min} and b_{\max} .

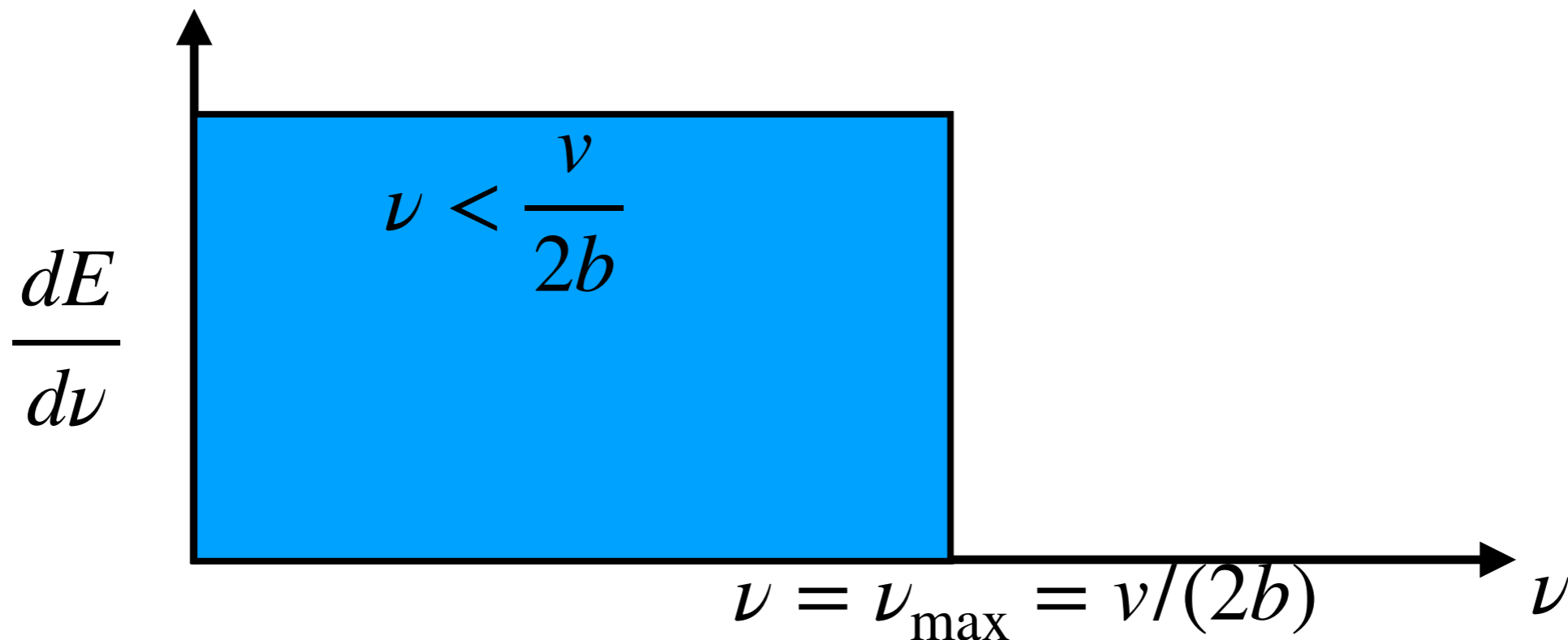

Bremsstrahlung

- Therefore energy radiated per unit frequency per unit time per unit volume:

$$\frac{dE}{d\nu dt dV} = \int_{b_{\min}}^{b_{\max}} P_{\max} (\Delta t)^2 \cdot n_e v 2\pi b db$$

Energy per frequency
per event

Events per time per
volume

- Now just need to work out limits b_{\min} and b_{\max} .

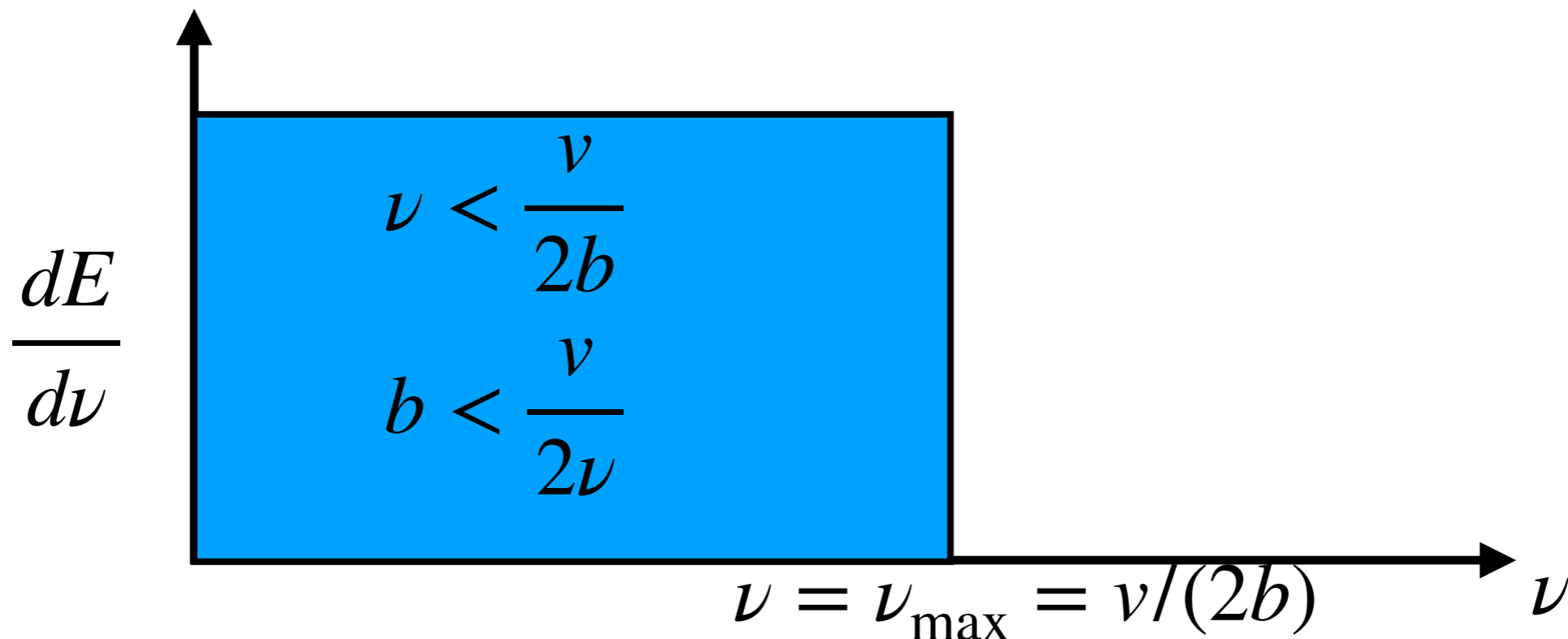

Bremsstrahlung

- Therefore energy radiated per unit frequency per unit time per unit volume:

$$\frac{dE}{d\nu dt dV} = \int_{b_{\min}}^{b_{\max}} P_{\max} (\Delta t)^2 \cdot n_e v 2\pi b db$$

Energy per frequency
per event

Events per time per
volume

- Now just need to work out limits b_{\min} and b_{\max} .

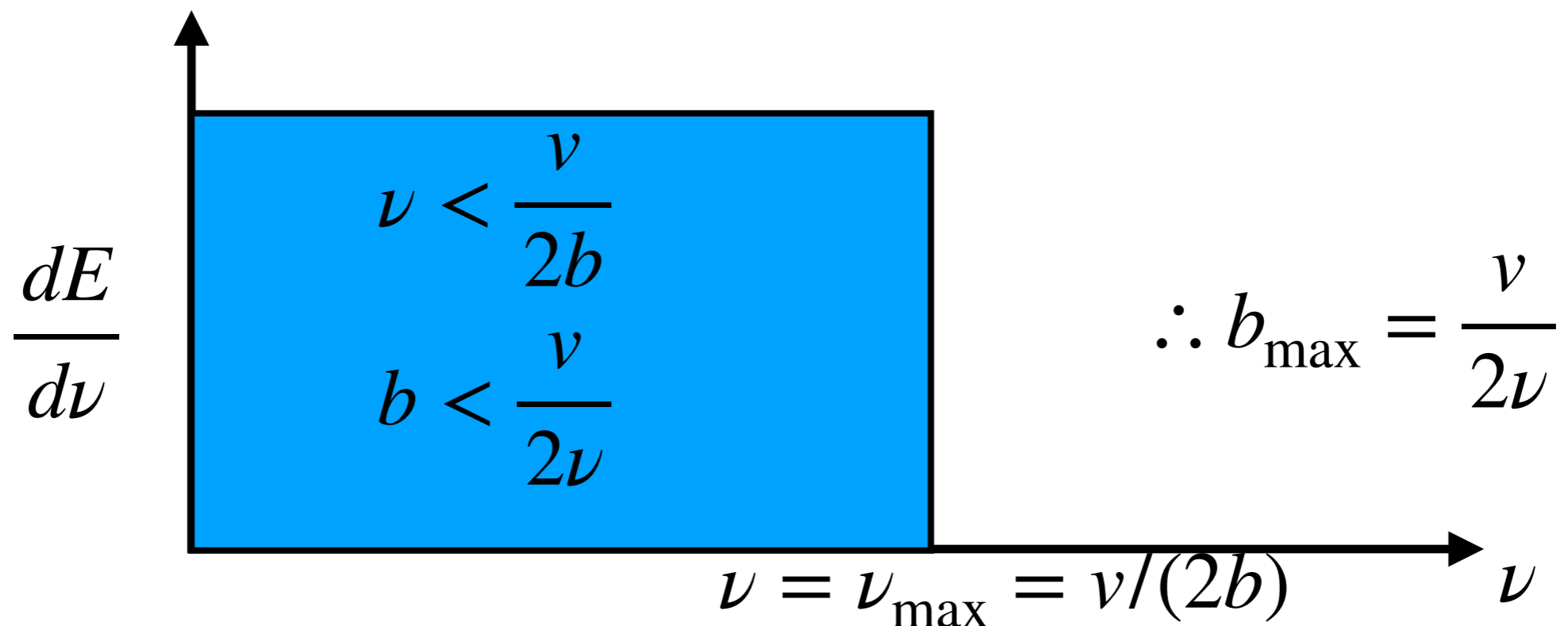

Bremsstrahlung

- Therefore energy radiated per unit frequency per unit time per unit volume:

$$\frac{dE}{d\nu dt dV} = \int_{b_{\min}}^{b_{\max}} P_{\max} (\Delta t)^2 \cdot n_e v 2\pi b db$$

Energy per frequency
per event

Events per time per
volume

- Now just need to work out limits b_{\min} and b_{\max} .
- Max: $b_{\max} = v/(2\nu)$
- Minimum impact parameter given by the quantum limit:

$$m_e v \cdot b_{\min} = \hbar$$

$$\therefore b_{\min} = \hbar/(m_e v)$$

Bremsstrahlung

$$P_{\max} = \frac{q^2 \sigma_T c}{16\pi^2 \epsilon_0 b^4} \implies$$

$$\frac{dE}{d\nu dt dV} \approx \int_{b_{\min}}^{b_{\max}} P_{\max} (\Delta t)^2 \cdot n_e \nu 2\pi b db = \frac{q^2 c n_e n_i \sigma_T}{4\pi \epsilon_0 \nu} \ln \left(\frac{b_{\max}}{b_{\min}} \right)$$

Bremsstrahlung

$$P_{\max} = \frac{q^2 \sigma_T c}{16\pi^2 \epsilon_0 b^4} \implies$$

$$\frac{dE}{d\nu dt dV} \approx \int_{b_{\min}}^{b_{\max}} P_{\max} (\Delta t)^2 \cdot n_e v 2\pi b db = \frac{q^2 c n_e n_i \sigma_T}{4\pi \epsilon_0 v} \ln \left(\frac{b_{\max}}{b_{\min}} \right)$$

$$b_{\max} = v / (2\nu)$$

$$b_{\min} = \hbar / (m_e v)$$

$$\implies \frac{dE}{d\nu dt dV} \approx \frac{q^2 c n_e n_i \sigma_T}{4\pi \epsilon_0 v} \ln \left(\frac{\frac{1}{2} m_e v^2}{\hbar \nu} \right)$$

Bremsstrahlung

$$P_{\max} = \frac{q^2 \sigma_T c}{16\pi^2 \epsilon_0 b^4} \implies$$

$$\frac{dE}{d\nu dt dV} \approx \int_{b_{\min}}^{b_{\max}} P_{\max} (\Delta t)^2 \cdot n_e v 2\pi b db = \frac{q^2 c n_e n_i \sigma_T}{4\pi \epsilon_0 v} \ln \left(\frac{b_{\max}}{b_{\min}} \right)$$

$$b_{\max} = v / (2\nu)$$

$$b_{\min} = \hbar / (m_e v)$$

$$\implies \frac{dE}{d\nu dt dV} \approx \frac{q^2 c n_e n_i \sigma_T}{4\pi \epsilon_0 v} \ln \left(\frac{\frac{1}{2} m_e v^2}{\hbar \nu} \right)$$

...typo in problem 10.5a

Bremsstrahlung

$$P_{\max} = \frac{q^2 \sigma_T c}{16\pi^2 \epsilon_0 b^4} \implies$$

$$\frac{dE}{d\nu dt dV} \approx \int_{b_{\min}}^{b_{\max}} P_{\max} (\Delta t)^2 \cdot n_e v 2\pi b db = \frac{q^2 c n_e n_i \sigma_T}{4\pi \epsilon_0 v} \ln \left(\frac{b_{\max}}{b_{\min}} \right)$$

$$b_{\max} = v/(2\nu) \qquad b_{\min} = \hbar/(m_e v)$$

$$\implies \frac{dE}{d\nu dt dV} \approx \frac{q^2 c n_e n_i \sigma_T}{4\pi \epsilon_0 v} \ln \left(\frac{\frac{1}{2} m_e v^2}{\hbar \nu} \right)$$

- Thermal distribution of electrons: $\frac{1}{2} m_e v^2 = \frac{3}{2} k_B T_e$ (lecture 7)

Bremsstrahlung

$$P_{\max} = \frac{q^2 \sigma_T c}{16\pi^2 \epsilon_0 b^4} \implies$$

$$\frac{dE}{d\nu dt dV} \approx \int_{b_{\min}}^{b_{\max}} P_{\max} (\Delta t)^2 \cdot n_e v 2\pi b db = \frac{q^2 c n_e n_i \sigma_T}{4\pi \epsilon_0 v} \ln \left(\frac{b_{\max}}{b_{\min}} \right)$$

$$b_{\max} = v/(2\nu) \qquad b_{\min} = \hbar/(m_e v)$$

$$\implies \frac{dE}{d\nu dt dV} \approx \frac{q^2 c n_e n_i \sigma_T}{4\pi \epsilon_0 v} \ln \left(\frac{\frac{1}{2} m_e v^2}{\hbar \nu} \right)$$

- Thermal distribution of electrons: $\frac{1}{2} m_e v^2 = \frac{3}{2} k_B T_e$
- Ion density: $n_i \propto n_e$
- Therefore spectrum:

$$F_\nu \propto \frac{dE}{d\nu dt dV} \propto \frac{n_i^2}{T_e^{1/2}} \ln \left(\frac{3\pi k_B T_e}{h\nu} \right)$$

Bremsstrahlung

- Simple calculation (red) gets the basic characteristics (n & T dependence plus cut-off energy), but misses exact shape (black).
- Can measure cluster temperature and density from X-ray spectrum.

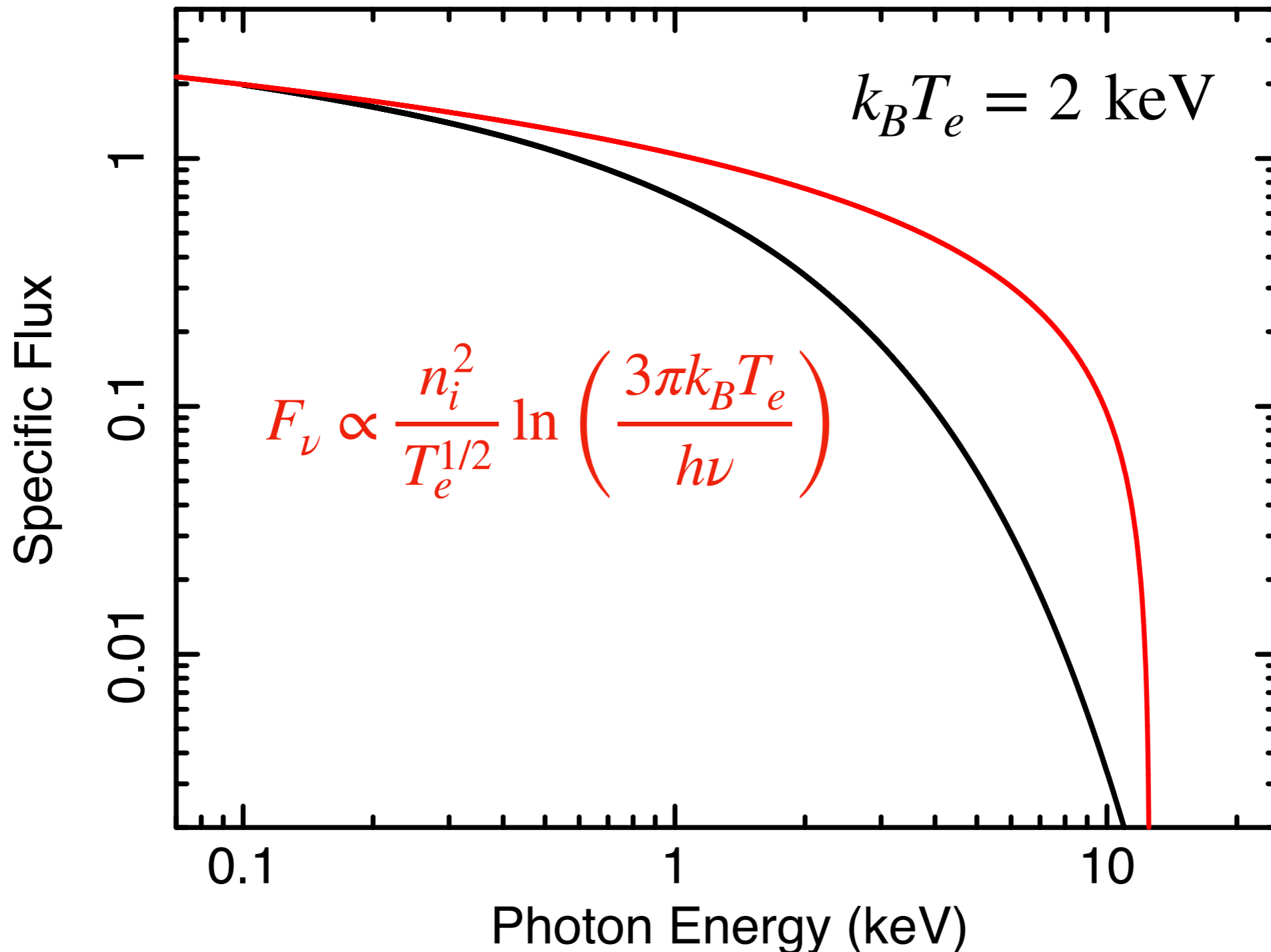

Sunyaev-Zeldovich Effect

- A fraction of Cosmic Microwave Background (CMB) photons passing through a cluster will be Compton up-scattered by hot electrons in the ICM.
- CMB photons have long wavelengths and the electrons are reasonably hot ($kT_e \sim \text{few keV}$), therefore photons gain energy (let's say fractional gain is x)

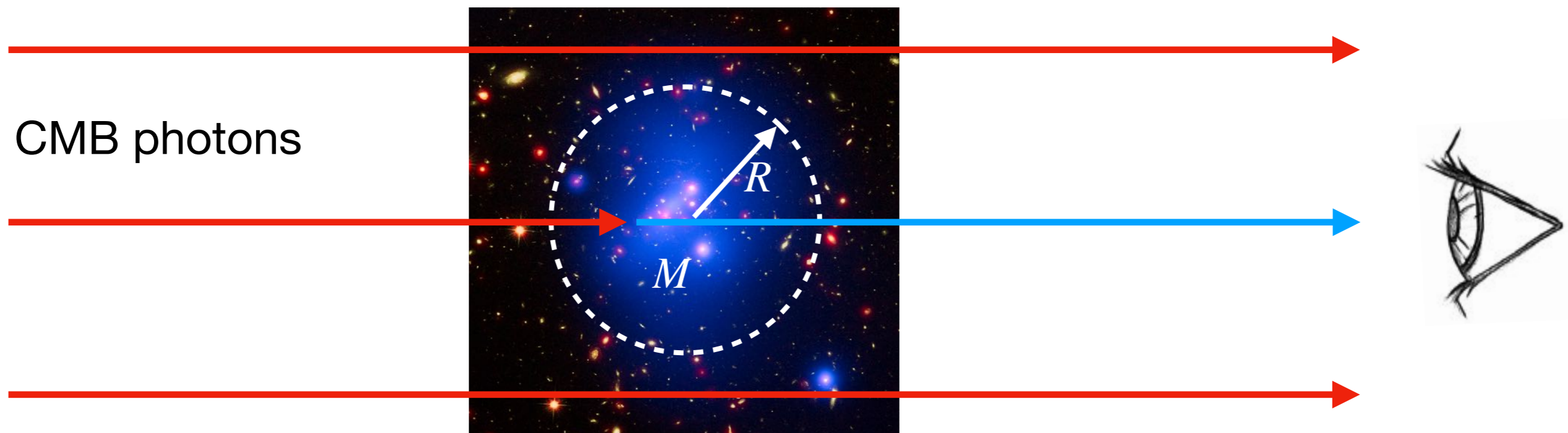

Sunyaev-Zeldovich Effect

- A fraction of Cosmic Microwave Background (CMB) photons passing through a cluster will be Compton up-scattered by hot electrons in the ICM.
- CMB photons have long wavelengths and the electrons are reasonably hot ($kT_e \sim \text{few keV}$), therefore photons gain energy (let's say fractional gain is x)

$$\epsilon_s = x\epsilon_0 = (1 + \Delta\epsilon/\epsilon)\epsilon_0$$

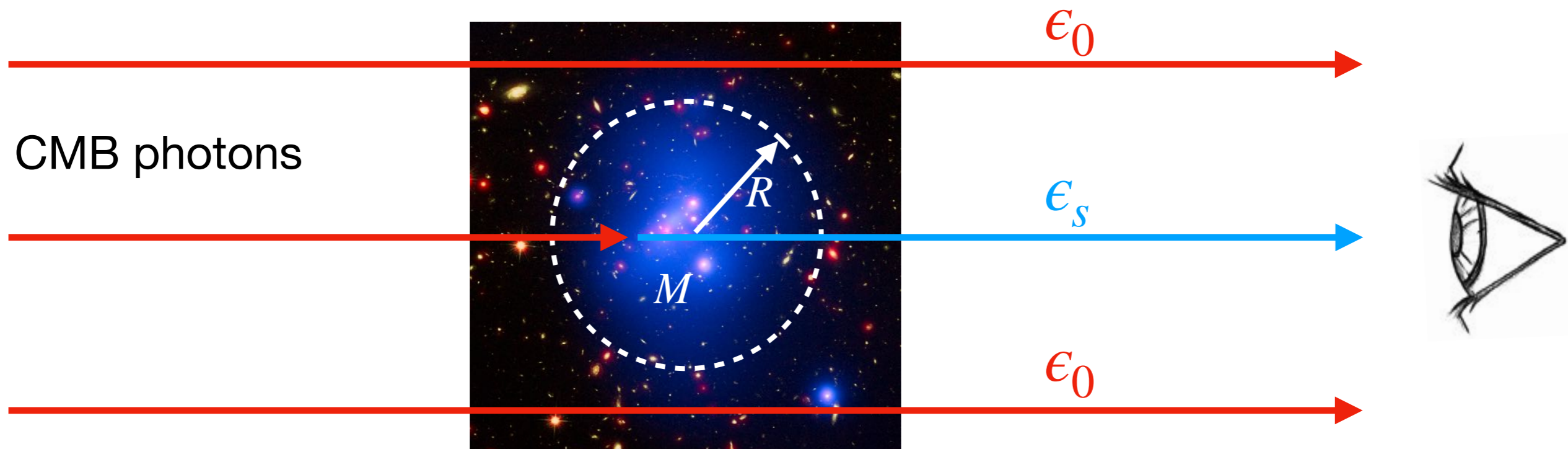

Sunyaev-Zeldovich Effect

- A fraction of Cosmic Microwave Background (CMB) photons passing through a cluster will be Compton up-scattered by hot electrons in the ICM.
- CMB photons have long wavelengths and the electrons are reasonably hot ($kT_e \sim \text{few keV}$), therefore photons gain energy (let's say fractional gain is x)
- Since the scattered photons on average gain energy, the blackbody function of the scattered photons has a higher effective temperature.

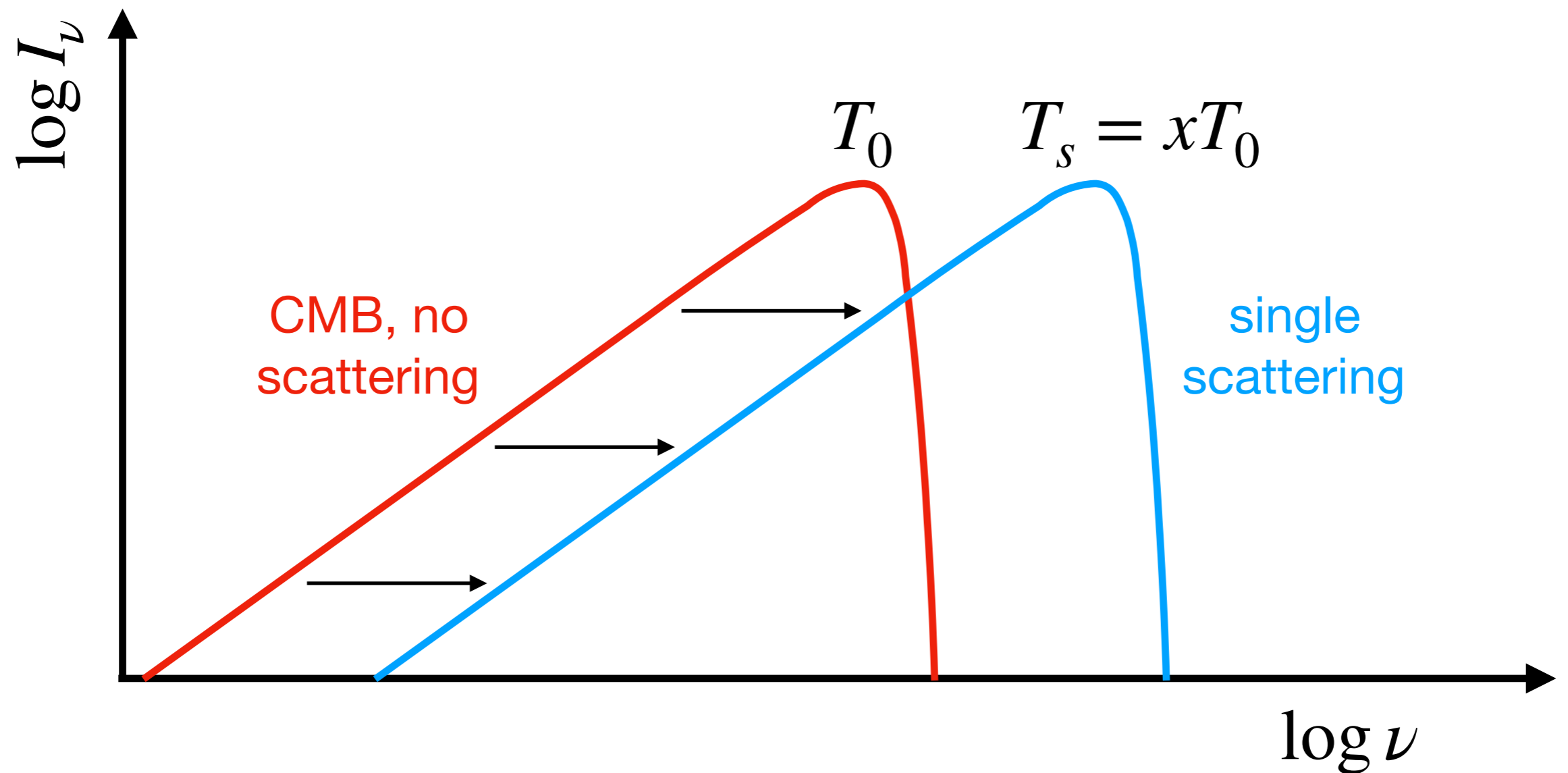

Sunyaev-Zeldovich Effect

- Scattering conserves photons, so if the input spectrum were $I_\nu^0 = B_\nu(T_0)$ and each photon were scattered once, the output spectrum would be:

$$I_\nu^s = AB_\nu(T_s)$$

where:
$$\int_0^\infty \frac{I_\nu^s}{h\nu} d\nu = \int_0^\infty \frac{I_\nu^0}{h\nu} d\nu$$

Sunyaev-Zeldovich Effect

- Scattering conserves photons, so if the input spectrum were $I_\nu^0 = B_\nu(T_0)$ and each photon were scattered once, the output spectrum would be:

$$I_\nu^s = AB_\nu(T_s)$$

where:
$$\int_0^\infty \frac{I_\nu^s}{h\nu} d\nu = \int_0^\infty \frac{I_\nu^0}{h\nu} d\nu$$

$$B_\nu(T) = \frac{2h\nu^3/c^2}{\exp(h\nu/kT) - 1}$$

Sunyaev-Zeldovich Effect

- Scattering conserves photons, so if the input spectrum were $I_\nu^0 = B_\nu(T_0)$ and each photon were scattered once, the output spectrum would be:

$$I_\nu^s = AB_\nu(T_s)$$

where:
$$\int_0^\infty \frac{I_\nu^s}{h\nu} d\nu = \int_0^\infty \frac{I_\nu^0}{h\nu} d\nu$$

$$B_\nu(T) = \frac{2h\nu^3/c^2}{\exp(h\nu/kT) - 1}$$

$$\therefore A \int_0^\infty \frac{\nu^2}{\exp(kT_s/h\nu) - 1} d\nu = \int_0^\infty \frac{\nu^2}{\exp(kT_0/h\nu) - 1} d\nu$$

Sunyaev-Zeldovich Effect

- Scattering conserves photons, so if the input spectrum were $I_\nu^0 = B_\nu(T_0)$ and each photon were scattered once, the output spectrum would be:

$$I_\nu^s = AB_\nu(T_s)$$

where:
$$\int_0^\infty \frac{I_\nu^s}{h\nu} d\nu = \int_0^\infty \frac{I_\nu^0}{h\nu} d\nu$$

$$B_\nu(T) = \frac{2h\nu^3/c^2}{\exp(h\nu/kT) - 1}$$

$$\therefore A \int_0^\infty \frac{\nu^2}{\exp(kT_s/h\nu) - 1} d\nu = \int_0^\infty \frac{\nu^2}{\exp(kT_0/h\nu) - 1} d\nu$$

- Sub in $\mu = \nu/x$: ($d\nu/d\mu = x$)

$$A \int_0^\infty \frac{x^3 \mu^2}{\exp(kT_0/h\mu) - 1} d\mu = \int_0^\infty \frac{\nu^2}{\exp(kT_0/h\nu) - 1} d\nu$$

Sunyaev-Zeldovich Effect

- Scattering conserves photons, so if the input spectrum were $I_\nu^0 = B_\nu(T_0)$ and each photon were scattered once, the output spectrum would be:

$$I_\nu^S = AB_\nu(T_s)$$

where:
$$\int_0^\infty \frac{I_\nu^S}{h\nu} d\nu = \int_0^\infty \frac{I_\nu^0}{h\nu} d\nu$$

$$B_\nu(T) = \frac{2h\nu^3/c^2}{\exp(h\nu/kT) - 1}$$

$$\therefore A \int_0^\infty \frac{\nu^2}{\exp(kT_s/h\nu) - 1} d\nu = \int_0^\infty \frac{\nu^2}{\exp(kT_0/h\nu) - 1} d\nu$$

- Sub in $\mu = \nu/x$: ($d\nu/d\mu = x$)

$$A \int_0^\infty \frac{x^3 \mu^2}{\exp(kT_0/h\mu) - 1} d\mu = \int_0^\infty \frac{\nu^2}{\exp(kT_0/h\nu) - 1} d\nu$$

$$\therefore A = 1/x^3$$

$$\therefore I_\nu^S = x^{-3} B_\nu(T_s)$$

Sunyaev-Zeldovich Effect

- Scattering *reduces* the specific intensity for low photon frequencies (Rayleigh-Jeans) and *increases* it for high photon frequencies (Wien).

$$I_\nu^0 = B_\nu(T_0)$$

$$I_\nu^s = x^{-3} B_\nu(T_s)$$

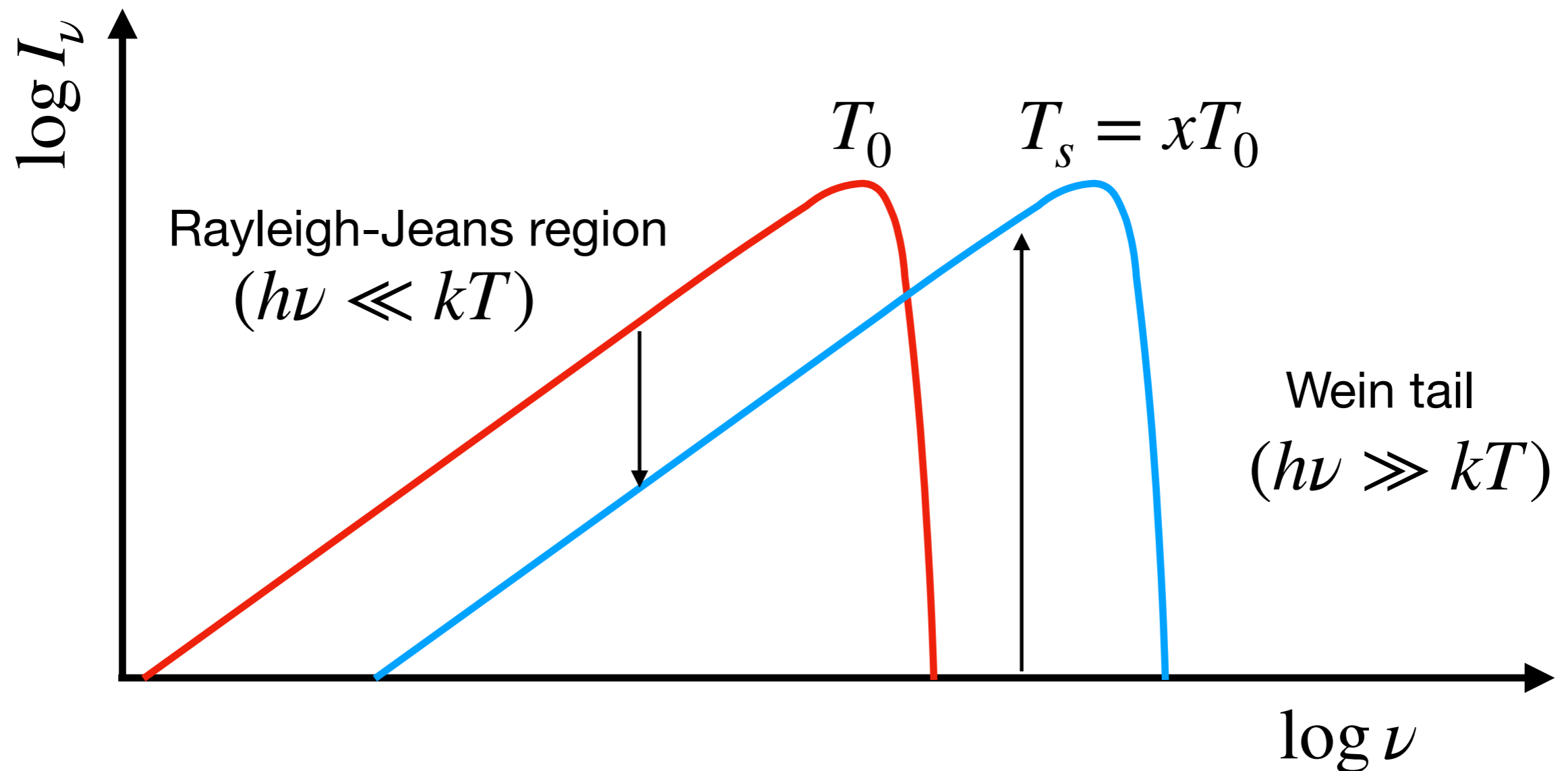

Sunyaev-Zeldovich Effect

- The CMB spectrum we see from the cluster includes some photons that underwent no scatterings and some that underwent one (plus higher orders, but assume low optical depth).
- Low optical depth: $\tau \ll 1 \implies I_\nu \approx (1 - \tau)I_\nu^0 + \tau I_\nu^S$

Sunyaev-Zeldovich Effect

- The CMB spectrum we see from the cluster includes some photons that underwent no scatterings and some that underwent one (plus higher orders, but assume low optical depth).
- Low optical depth: $\tau \ll 1 \implies I_\nu \approx (1 - \tau)I_\nu^0 + \tau I_\nu^S$
- Therefore fractional change in CMB specific intensity compared with a patch of sky containing no cluster:

$$\frac{\delta I_\nu}{I_\nu} = \frac{I_\nu - I_\nu^0}{I_\nu^0} \approx \frac{(1 - \tau)I_\nu^0 + \tau I_\nu^S - I_\nu^0}{I_\nu^0}$$

Sunyaev-Zeldovich Effect

- The CMB spectrum we see from the cluster includes some photons that underwent no scatterings and some that underwent one (plus higher orders, but assume low optical depth).
- Low optical depth: $\tau \ll 1 \implies I_\nu \approx (1 - \tau)I_\nu^0 + \tau I_\nu^s$
- Therefore fractional change in CMB specific intensity compared with a patch of sky containing no cluster:

$$\frac{\delta I_\nu}{I_\nu} = \frac{I_\nu - I_\nu^0}{I_\nu^0} \approx \frac{(1 - \tau)I_\nu^0 + \tau I_\nu^s - I_\nu^0}{I_\nu^0} = -\tau + \tau x^{-3} \frac{B_\nu(T_s)}{B_\nu(T_0)}$$

Sunyaev-Zeldovich Effect

- The CMB spectrum we see from the cluster includes some photons that underwent no scatterings and some that underwent one (plus higher orders, but assume low optical depth).
- Low optical depth: $\tau \ll 1 \implies I_\nu \approx (1 - \tau)I_\nu^0 + \tau I_\nu^s$
- Therefore fractional change in CMB specific intensity compared with a patch of sky containing no cluster:

$$\frac{\delta I_\nu}{I_\nu} = \frac{I_\nu - I_\nu^0}{I_\nu^0} \approx \frac{(1 - \tau)I_\nu^0 + \tau I_\nu^s - I_\nu^0}{I_\nu^0} = -\tau + \tau x^{-3} \frac{B_\nu(T_s)}{B_\nu(T_0)}$$

- Let's look at radio frequencies, well below CMB peak:

Rayleigh-Jeans law: $B_\nu(T) \approx 2\nu^2 kT/c^2$

Sunyaev-Zeldovich Effect

- The CMB spectrum we see from the cluster includes some photons that underwent no scatterings and some that underwent one (plus higher orders, but assume low optical depth).
- Low optical depth: $\tau \ll 1 \implies I_\nu \approx (1 - \tau)I_\nu^0 + \tau I_\nu^s$
- Therefore fractional change in CMB specific intensity compared with a patch of sky containing no cluster:

$$\frac{\delta I_\nu}{I_\nu} = \frac{I_\nu - I_\nu^0}{I_\nu^0} \approx \frac{(1 - \tau)I_\nu^0 + \tau I_\nu^s - I_\nu^0}{I_\nu^0} = -\tau + \tau x^{-3} \frac{B_\nu(T_s)}{B_\nu(T_0)}$$

- Let's look at radio frequencies, well below CMB peak:

$$\text{Rayleigh-Jeans law: } B_\nu(T) \approx 2\nu^2 kT / c^2$$

- Therefore for radio frequencies:

$$\frac{\delta I_\nu}{I_\nu} \approx \tau \left(-1 + x^{-3} \frac{xT_0}{T_0} \right) = \tau(x^{-2} - 1)$$

Sunyaev-Zeldovich Effect

$$\frac{\delta I_\nu}{I_\nu} \approx \tau(x^{-2} - 1)$$

Sunyaev-Zeldovich Effect

$$\frac{\delta I_\nu}{I_\nu} \approx \tau(x^{-2} - 1)$$

$$x = 1 + (\Delta\epsilon/\epsilon) \implies x^{-2} \approx 1 - 2(\Delta\epsilon/\epsilon)$$

(first order binomial expansion)

Sunyaev-Zeldovich Effect

$$\frac{\delta I_\nu}{I_\nu} \approx \tau(x^{-2} - 1)$$

$$x = 1 + (\Delta\epsilon/\epsilon) \implies x^{-2} \approx 1 - 2(\Delta\epsilon/\epsilon)$$

(first order binomial expansion)

$$\therefore \frac{\delta I_\nu}{I_\nu} \approx -2\tau \frac{\Delta\epsilon}{\epsilon}$$

Sunyaev-Zeldovich Effect

$$\frac{\delta I_\nu}{I_\nu} \approx \tau(x^{-2} - 1)$$

$$x = 1 + (\Delta\epsilon/\epsilon) \implies x^{-2} \approx 1 - 2(\Delta\epsilon/\epsilon)$$

(first order binomial expansion)

$$\therefore \frac{\delta I_\nu}{I_\nu} \approx -2\tau \frac{\Delta\epsilon}{\epsilon}$$

Confusing jargon warning: radio astronomers are mad-keen on brightness temperature, so it is common to hear that the SZ effect reduces the CMB temperature. It doesn't really, it just decreases the brightness temperature inferred by observing only in a radio band (the colour temperature increases).

In Rayleigh-Jeans limit:

$$\frac{\delta T_b}{T_b} = \frac{\delta I_\nu}{I_\nu}$$

Sunyaev-Zeldovich Effect

$$\therefore \frac{\delta I_\nu}{I_\nu} \approx -2\tau \frac{\Delta\epsilon}{\epsilon}$$

- Electrons are thermal and so we can go back to our thermal Comptonisation discussion from lecture 7:

$$\left\langle \frac{\Delta\epsilon}{\epsilon} \right\rangle = 4 \frac{kT_e}{m_e c^2} - \frac{h\nu}{m_e c^2} \approx 4 \frac{kT_e}{m_e c^2}$$

(Since we are considering very long wavelengths)

Sunyaev-Zeldovich Effect

$$\therefore \frac{\delta I_\nu}{I_\nu} \approx -2\tau \frac{\Delta\epsilon}{\epsilon}$$

- Electrons are thermal and so we can go back to our thermal Comptonisation discussion from lecture 7:

$$\left\langle \frac{\Delta\epsilon}{\epsilon} \right\rangle = 4 \frac{kT_e}{m_e c^2} - \frac{h\nu}{m_e c^2} \approx 4 \frac{kT_e}{m_e c^2} \quad (\text{Since we are considering very long wavelengths})$$

- Note: It is for some reason common to ignore the factor of 4 in discussions of the SZ effect. I will keep the factor of 4 (in the homework problem too).

Sunyaev-Zeldovich Effect

$$\therefore \frac{\delta I_\nu}{I_\nu} \approx -2\tau \frac{\Delta\epsilon}{\epsilon}$$

- Electrons are thermal and so we can go back to our thermal Comptonisation discussion from lecture 7:

$$\left\langle \frac{\Delta\epsilon}{\epsilon} \right\rangle = 4 \frac{kT_e}{m_e c^2} - \frac{h\nu}{m_e c^2} \approx 4 \frac{kT_e}{m_e c^2} \quad (\text{Since we are considering very long wavelengths})$$

- Note: It is for some reason common to ignore the factor of 4 in discussions of the SZ effect. I will keep the factor of 4 (in the homework problem too).
- The optical depth of the cluster is: $\tau \approx 2Rn_e\sigma_T$, where R is radius of the cluster

- Therefore:

$$\therefore \frac{\delta I_\nu}{I_\nu} \approx -16Rn_e\sigma_T \frac{kT_e}{m_e c^2}$$

Sunyaev-Zeldovich Effect

$$\frac{\delta I_\nu}{I_\nu} \approx -16Rn_e\sigma_T\frac{kT_e}{m_e c^2}$$

- We can be a little more precise by allowing for changes of density and electron temperature within the cluster:

$$\frac{\delta I_\nu}{I_\nu} \approx -8\sigma_T \int_0^\infty n_e \frac{kT_e}{m_e c^2} d\ell$$

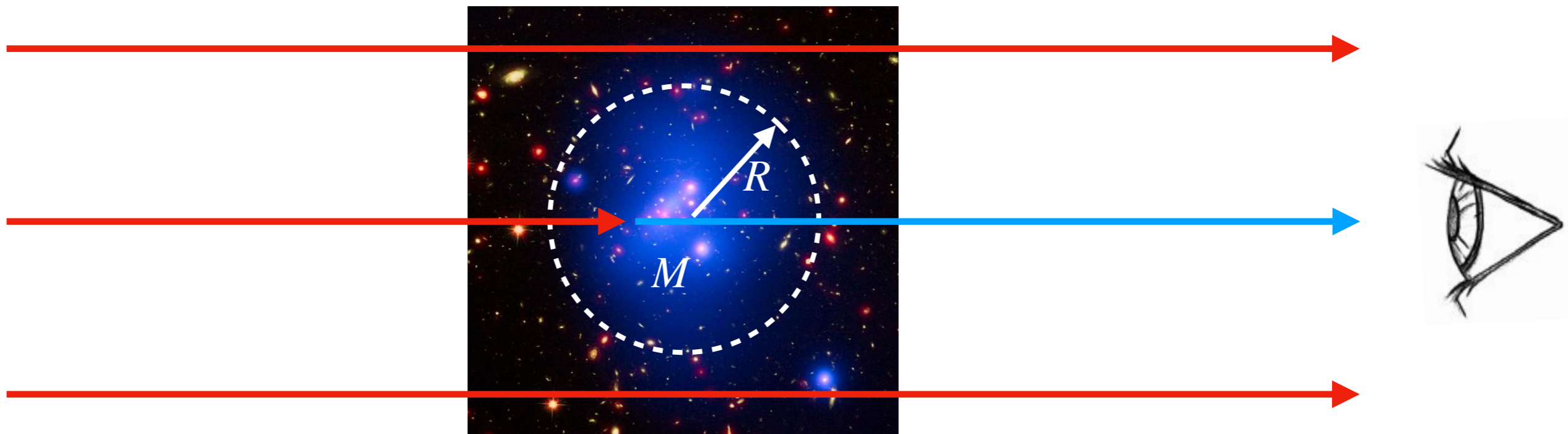

Sunyaev-Zeldovich Effect

- The beauty of this is that we can measure the cluster density and temperature from X-ray observations of the hot gas, and then use the SZ effect to infer the radius of the cluster, R .

$$\frac{\delta I_\nu}{I_\nu} \approx -16Rn_e\sigma_T\frac{kT_e}{m_e c^2}$$

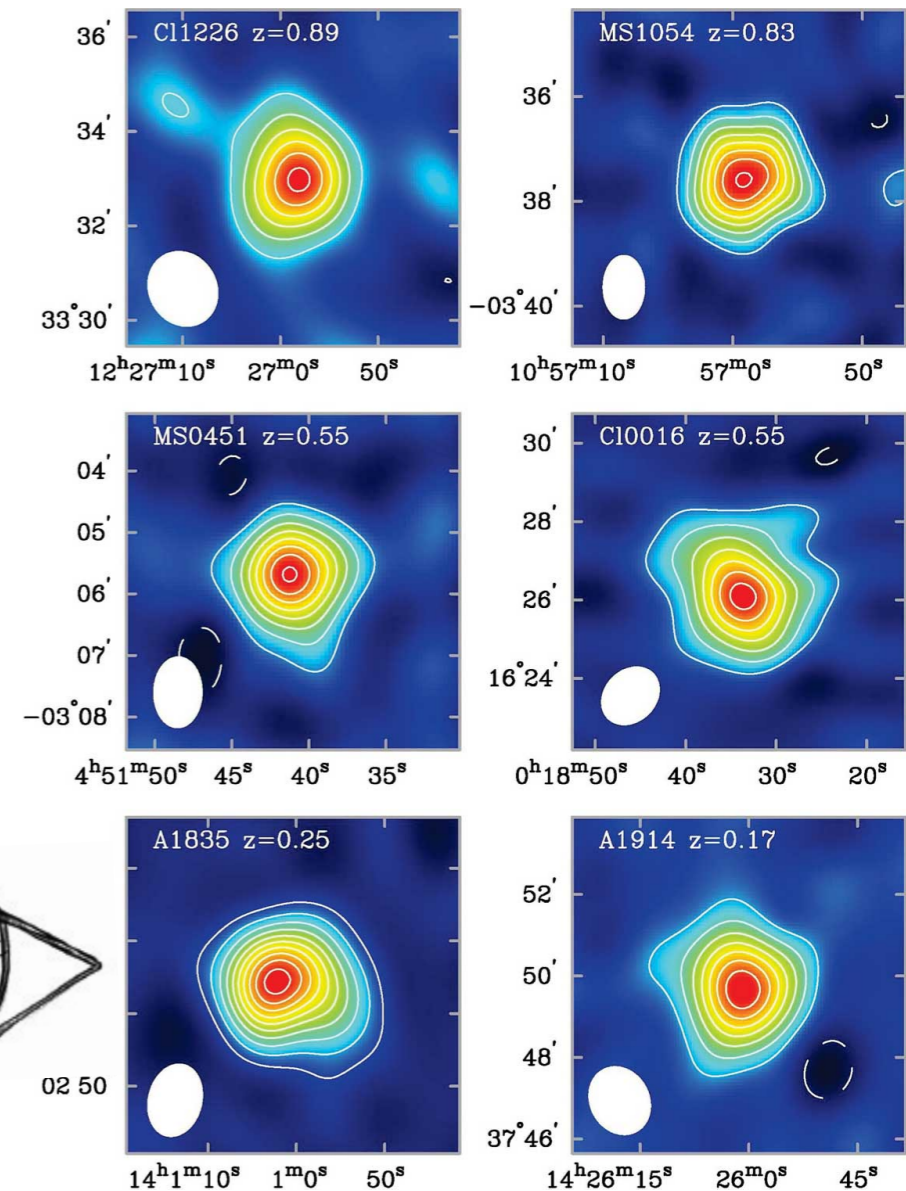
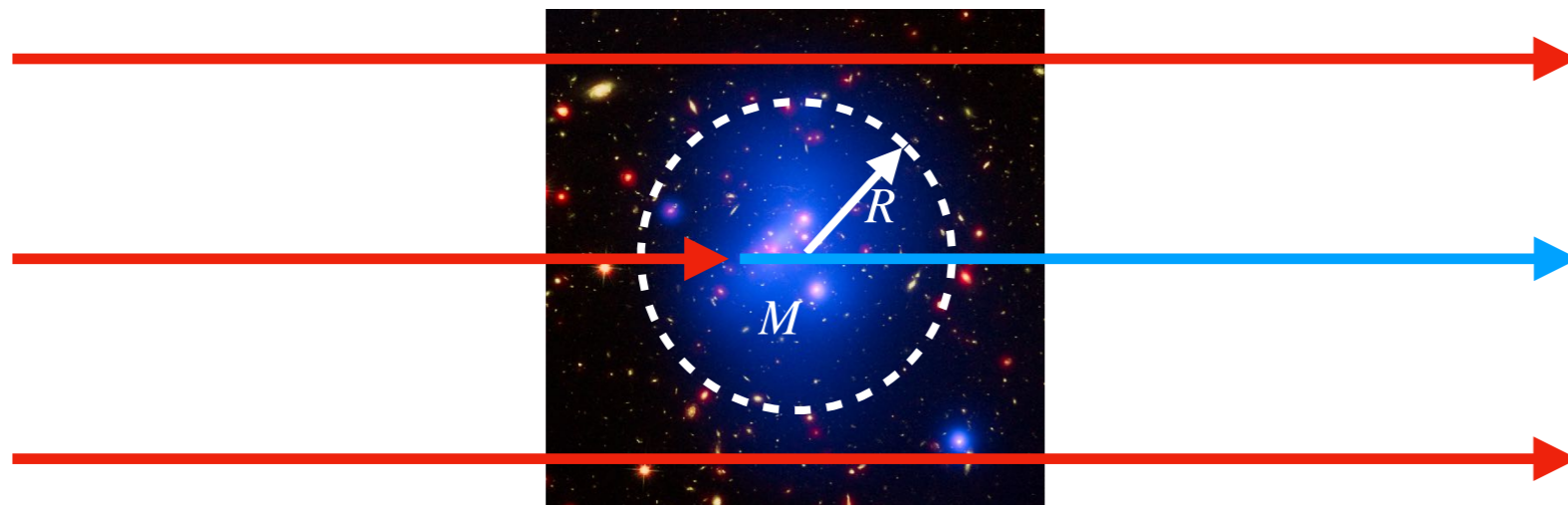

Sunyaev-Zeldovich Effect

- The beauty of this is that we can measure the cluster density and temperature from X-ray observations of the hot gas, and then use the SZ effect to infer the radius of the cluster, R .

$$\frac{\delta I_\nu}{I_\nu} \approx -16Rn_e\sigma_T\frac{kT_e}{m_e c^2}$$

- We can then compare R with the measured angular radius to get the distance to the cluster.
- Comparison with redshift gives a measure of the Hubble constant!

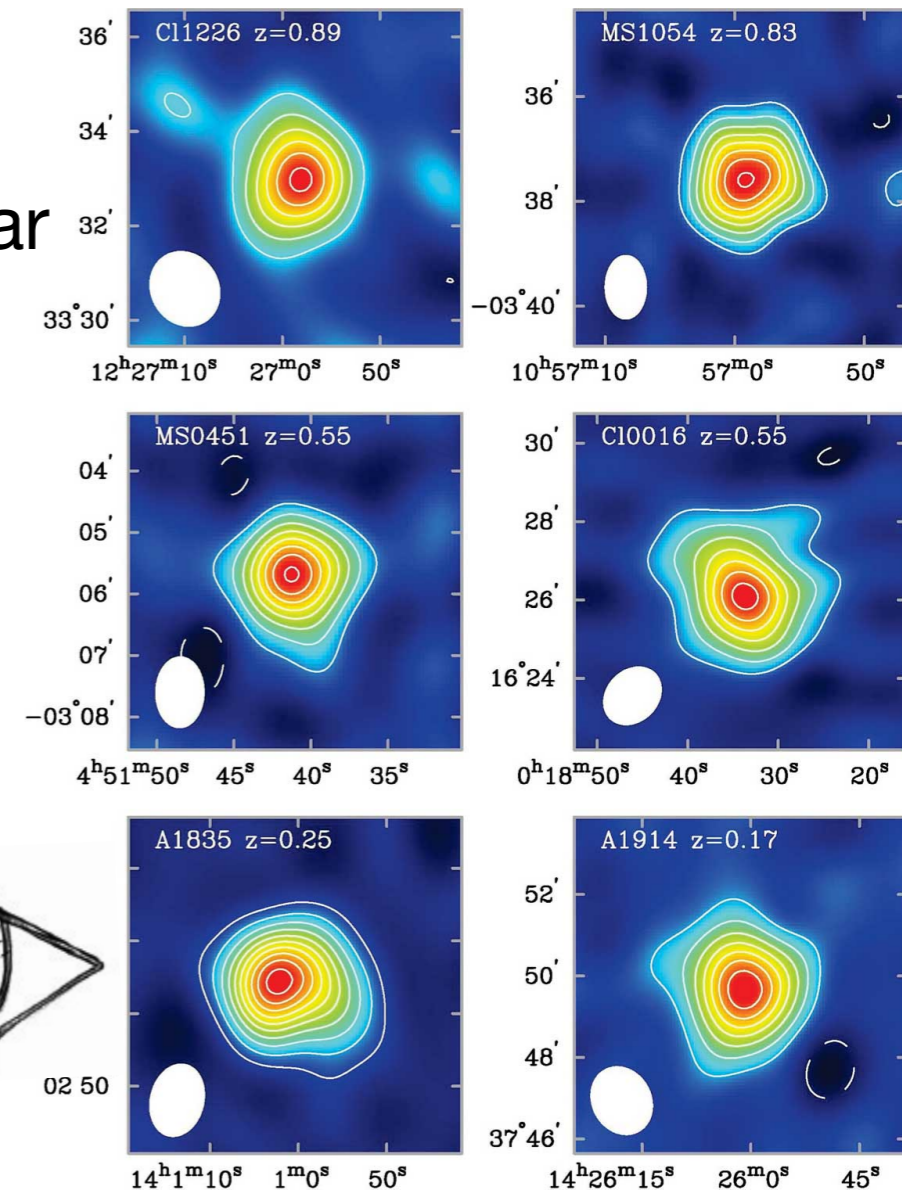
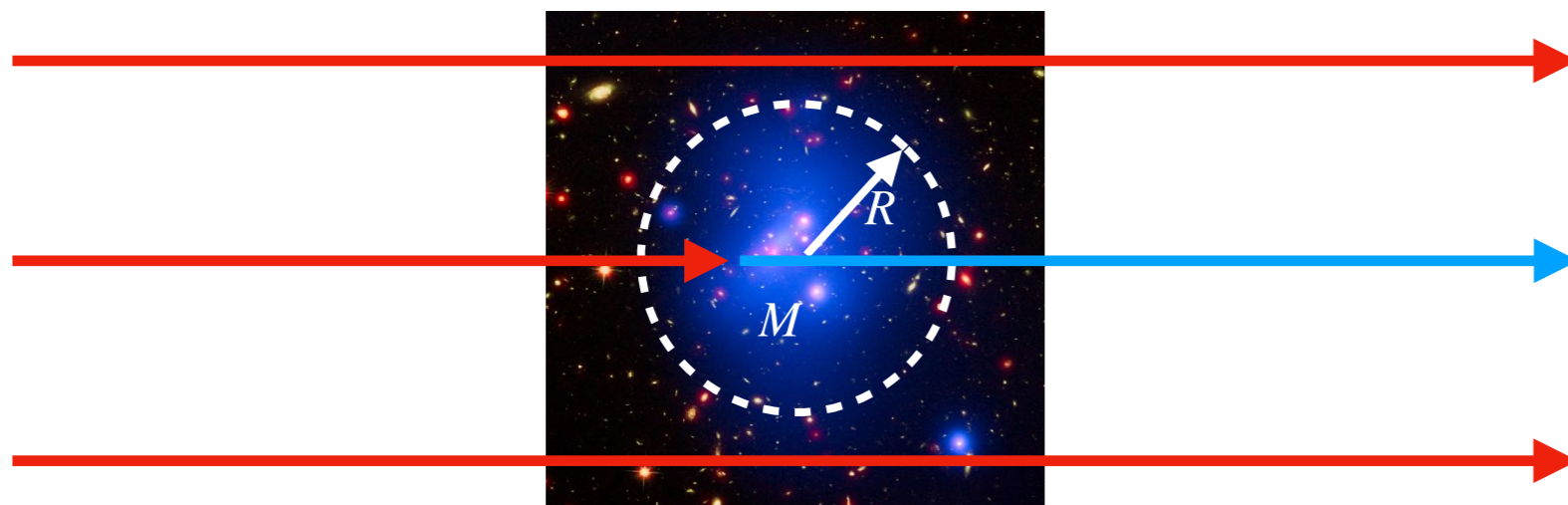

Sunyaev-Zeldovich Effect

- The beauty of this is that we can measure the cluster density and temperature from X-ray observations of the hot gas, and then use the SZ effect to infer the radius of the cluster, R .

$$\frac{\delta I_\nu}{I_\nu} \approx -16Rn_e\sigma_T\frac{kT_e}{m_e c^2}$$

- We can then compare R with the measured angular radius to get the distance to the cluster.
- Comparison with redshift gives a measure of the Hubble constant!
- Non-spherical, but averages out if we do this for many clusters.

